

JVC®

TV/VCR COMBO USER'S GUIDE

For models:

TV-13142

TV-13142W

VHS

**SQPB
4 HEAD**





(Illustration of TV-13142)

IMPORTANT NOTE TO THE CUSTOMER:

In the space below, enter the serial number for your television (located on the rear of the television cabinet). Staple your sales receipt or invoice to the inside cover of this guide. Keep this user's guide in a convenient place for future reference. Keep the carton and original packaging for future use.

Serial Number

	CAUTION RISK OF ELECTRIC SHOCK DO NOT OPEN	
<p>CAUTION: TO REDUCE THE RISK OF ELECTRIC SHOCK, DO NOT REMOVE COVER (OR BACK). NO USER-SERVICEABLE PARTS INSIDE. REFER SERVICING TO QUALIFIED SERVICE PERSONNEL.</p>		



The lightning flash with arrowhead symbol, within an equilateral triangle is intended to alert the user to the presence of uninsulated dangerous voltage within the product's enclosure that may be of sufficient magnitude to constitute a risk of electric shock to persons.



The exclamation point within an equilateral triangle is intended to alert the user to the presence of important operating and maintenance (servicing) instructions in the literature accompanying the appliance.

<p>WARNING: TO PREVENT FIRE OR SHOCK HAZARD, DO NOT EXPOSE THIS APPLIANCE TO RAIN OR MOISTURE.</p> <p>CAUTION: TO PREVENT ELECTRIC SHOCK DO NOT USE THIS POLARIZED PLUG WITH AN EXTENSION CORD, RECEPTACLE OR OTHER OUTLET UNLESS THE BLADES CAN BE FULLY INSERTED TO PREVENT BLADE EXPOSURE.</p>

WARNING: This equipment has been tested and found to comply with the limits for a Class B digital device, pursuant to Part 15 of the FCC Rules. These limits are designed to provide reasonable protection against harmful interference in a residential installation. This equipment generates, uses, and can radiate radio frequency energy and, if not installed and used in accordance with the instructions, may cause harmful interference to radio communications. However, there is no guarantee that interference will not occur in a particular installation. If this equipment does cause harmful interference to radio or television reception, which can be determined by turning the equipment off and on, the user is encouraged to try correcting the interference by one or more of the following measures:

- Reorient or relocate the receiving antenna.
- Increase the separation between the equipment and receiver.
- Connect the equipment into an outlet on a circuit different from that to which the receiver is connected.
- Consult the dealer or an experienced radio/TV technician for help.

CAUTION: Changes or modifications not expressly approved by the party responsible for compliance with the FCC Rules could void the user's authority to operate this equipment.

IMPORTANT SAFEGUARDS

1. READ INSTRUCTIONS

All the safety and operating instructions should be read before the unit is operated.

2. RETAIN INSTRUCTIONS

The safety and operating instructions should be retained for future reference.

3. HEED WARNINGS

All warnings on the unit and in the operating instructions should be adhered to.

4. FOLLOW INSTRUCTIONS

All operating and use instructions should be followed.

5. CLEANING

Unplug this unit from the wall outlet before cleaning. Do not use liquid cleaners or aerosol cleaners.

Use a damp cloth for cleaning.

6. ATTACHMENTS

Do not use attachments not recommended by the unit's manufacturer as they may cause hazards.

7. WATER AND MOISTURE

Do not use this unit near water. For example, near a bathtub, washbowl, kitchen sink, or laundry tub, in a wet basement, or near a swimming pool.

8. ACCESSORIES

Do not place this unit on an unstable cart, stand, tripod, bracket, or table.

The unit may fall, causing serious injury, and serious damage to the unit.

Use only with a cart, stand, tripod, bracket, or table recommended by the manufacturer.

- 8A. An appliance and cart combination should be moved with care. Quick stops, excessive force, and uneven surfaces may cause the appliance and cart combination to overturn.

9. VENTILATION

Slots and openings in the cabinet and in the back or bottom are provided for ventilation, and to ensure reliable operation of the unit, and to protect it from overheating. These openings must not be blocked or covered. The openings should never be blocked by placing the unit on a bed, sofa, rug, or other similar surface. This unit should never be placed near or over a radiator or heat source. This unit should not be placed in a built-in installation such as a bookcase or rack unless proper ventilation is provided or the manufacturer's instructions have been adhered to.

10. POWER SOURCES

This unit should be operated only from the type of power source indicated on the rating plate. If you are not sure of the type of power supply to your home, consult your appliance dealer or local power company. For units intended to operate from battery power, or other sources, refer to the operating instructions.

11. GROUNDING OR POLARIZATION

This unit is equipped with a polarized alternating-current line plug (a plug having one blade wider than the other). This plug will fit into the power outlet only one way. This is a safety feature. If you are unable to insert the plug fully into the outlet, try reversing the plug. If the plug should still fail to fit, contact your electrician to replace your obsolete outlet. Do not defeat the safety purpose of the polarized plug, if your unit is equipped with a 3-wire grounding-type plug, a plug having a third (grounding) pin. This plug will only fit into a grounding-type power outlet. This too, is a safety feature. If you are unable to insert the plug into the outlet, contact your electrician to replace your obsolete outlet.

Do not defeat the safety purpose of the grounding-type plug.

PORTABLE CART WARNING
(symbol provided by RETAC)



S3126A

12. POWER-CORD PROTECTION

Power-supply cords should be routed so that they are not likely to be walked on or pinched by items placed upon or against them, paying particular attention to cords at plugs, convenience receptacles, and the point where they exit from the appliance.

13. LIGHTNING

To protect your unit from a lightning storm, or when it is left unattended and unused for long periods of time, unplug it from the wall outlet and disconnect the antenna or cable system. This will prevent damage to the unit due to lightning and power line surges.

14. POWER LINES

An outside antenna system should not be located in the vicinity of overhead power lines or other electric light or power circuits, or where it can fall into such power lines or circuits. When installing an outside antenna system, extreme care should be taken to keep from touching such power lines or circuits, as contact with them might be fatal.

15. OVERLOADING

Do not overload wall outlets and extension cords, as this can result in a risk of fire or electric shock.

16. OBJECT AND LIQUID ENTRY

Do not push objects through any openings in this unit, as they may touch dangerous voltage points or short out parts that could result in fire or electric shock. Never spill or spray any type of liquid into the unit.

17. OUTDOOR ANTENNA GROUNDING

If an outside antenna or cable system is connected to the unit, be sure the antenna or cable system is grounded so as to provide some protection against voltage surges and built-up static charges, Section 810 of the National Electrical Code, ANSI/NFPA 70, provides information with respect to proper grounding of the mast and supporting structure, grounding of the lead-in wire to an antenna discharge unit, size of grounding conductors, location of antenna discharge unit, connection to grounding electrodes, and requirements for the grounding electrode.

18. SERVICING

Do not attempt to service this unit yourself as opening or removing covers may expose you to dangerous voltage or other hazards. Refer all servicing to qualified service personnel.

19. DAMAGE REQUIRING SERVICE

Unplug this unit from the wall outlet and refer servicing to qualified service personnel under the following conditions:

- a. When the power-supply cord or plug is damaged.
- b. If liquid has been spilled, or objects have fallen into the unit.
- c. If the unit has been exposed to rain or water.
- d. If the unit does not operate normally by following the operating instructions. Adjust only those controls that are covered by the operating instructions, as an improper adjustment of other controls may result in damage and will often require extensive work by a qualified technician to restore the unit to its normal operation.
- e. If the unit has been dropped or the cabinet has been damaged.
- f. When the unit exhibits a distinct change in performance, this indicates a need for service.

20. REPLACEMENT PARTS

When replacement parts are required, be sure the service technician uses replacement parts specified by the manufacturer or those that have the same characteristics as the original part. Unauthorized substitutions may result in fire, electric shock or other hazards.

21. SAFETY CHECK

Upon completion of any service or repairs to this unit, ask the service technician to perform safety checks to determine that the unit is in proper operating condition.

22. WALL OR CEILING MOUNTING

The product should be mounted to a wall or ceiling only as recommended by the manufacturer.

23. HEAT

The product should be situated away from heat sources such as radiators, heat registers, stoves, or other products (including amplifiers) that produce heat.

24. NOTE TO CATV SYSTEM INSTALLER

This reminder is provided to call the CATV system installer's attention to Article 820-40 of the NEC that provides guidelines for proper grounding and, in particular, specifies that the cable ground shall be connected to the grounding system of the building, as close to the point of cable entry as practical.

EXAMPLE OF ANTENNA GROUNDING AS PER THE
NATIONAL ELECTRICAL CODE

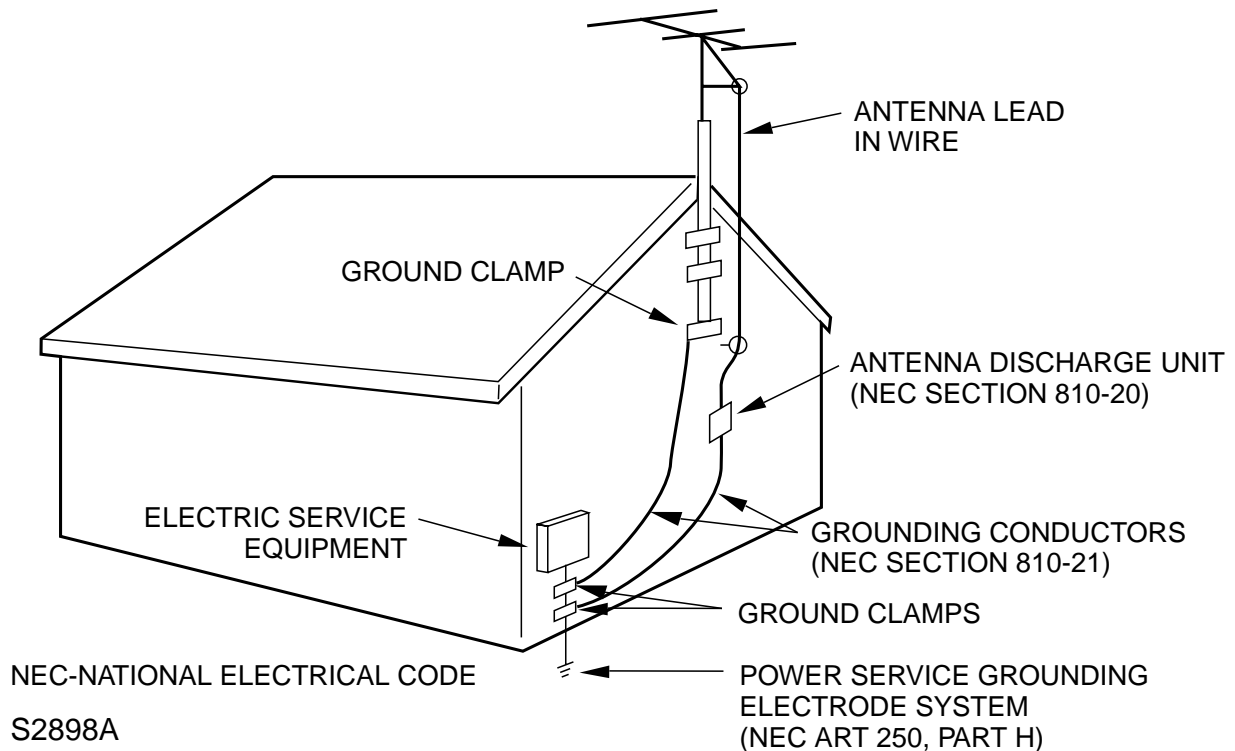

FEATURES

Color TV With Video Cassette Recorder - Unique space saving design combines a 13" color TV and a video cassette recorder.

High Quality Picture Technology - This TV/VCR equipped "HQ" incorporates VHS High Quality technology. A built-in detail enhancer is used to boost the recorded signal and provide maximum picture quality during playback. It is compatible with other VHS video cassette recorders.

SQPB - Tapes recorded in the S-VHS system can be played back simply on this TV/VCR.

4 Video Heads - Provides optimal picture quality for special effects playback.

Frequency Synthesized Tuner - Electronically locks in and memorizes all available channels for perfect reception with the touch of a button.

181 Channel Tuner - Receives standard VHF and UHF broadcast channels and up to 113 cable channels. The actual number of channels received depends upon channel reception in your area or your cable system.

Unified TV/VCR Random Access Remote Control - This remote control allows operating various TV and VCR functions from the comfort of your favorite viewing position.

Closed Caption Decoder With Full Text Mode - Displays text captions or full screen text on the screen for hearing impaired viewers.

8-Programs/ 1-Month Programmable Timer With Everyday/Every Week Capability - The built-in timer allows automatic absentee recording of up to 8 TV programs within 1 month. It is also possible to record a program which is broadcast at the same time everyday or every week.

Auto Clock Set - Once your TV/VCR is plugged into the AC outlet, it automatically sets the correct date and time.

On-Screen TV Display And VCR Programming - When you select a channel or make other changes, the TV will show an indicator on the screen for a few seconds. Timer recording can be programmed and confirmed on the screen.

Picture Adjustments Using The Remote Control - The On-Screen display allows precise remote control adjustment of BRIGHTNESS, CONTRAST, COLOR, TINT and SHARPNESS.

Automatic Playback/Rewind-Stop-Eject - When loading a cassette tape without the erase prevention tab, this TV/VCR will automatically play back the cassette tape at the correct speed. When a tape reaches its end during play-back, recording (except during ITR and Timer Record) and fast forward, it will automatically stop, rewind, stop and eject the tape.

Programmable ON/OFF Timer - Allows you to automatically turn on or off your TV/VCR at a set time.

Programmable TV Sleep Timer - Operable from the remote control, the TV can be programmed up to 120 minutes to turn off automatically.

Full Load Tape Transport - Permits rapid access between modes.

Automatic Repeat Play System - When Auto Repeat option is turned on, the TV/VCR will automatically play back the same cassette tape repeatedly.

Instant Timer Recording (ITR) - Simply by pressing the REC and PLAY buttons, the TV/VCR can be programmed for up to 5 hours of recording with an immediate start.

Audio/Video Input/Output Jacks - A VCR or other video device may be hooked up to this TV/VCR for dubbing or playback purposes.

2 Speed Picture Search - 3 or 5 times normal speed in SP mode (9X or 15X in EP).

2 Speed Record/ Playback - Records and plays two tape speeds (SP, EP).

Real Time Tape Counter With Zero Return - The counter displays the real tape time and the zero return can be used to return the tape to a preselected position (00:00:00) while the counter can be used to locate programs.

Digital Auto Tracking - Automatically adjusts tracking during playback for the best possible picture.

On-Screen 3 Language Display - You can select one of 3 languages, English, Spanish or French for on-screen programming.

V-Chip - The V-Chip function can rate a TV program or a movie content. It allows you to set a restriction level.

TABLE OF CONTENTS

It is recommended that you carefully read the descriptions and operating procedures contained in this User's Guide prior to operating your new TV/VCR.

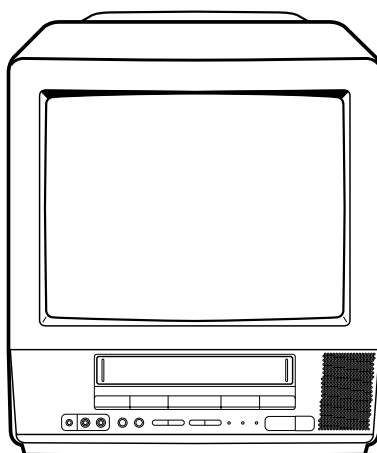

PREPARATION

PRECAUTIONS	6
LOCATION OF CONTROLS	8
REMOTE CONTROL	9
ANTENNA CONNECTIONS	11
CABLE TV CONNECTIONS	12
SETTING LANGUAGE	13
AUTO CLOCK SETTING	14
MANUAL CLOCK SETTING	16

TV OPERATION

TV OPERATION	17
TO MEMORIZE CHANNELS	21
SETTING THE V-CHIP	24
PICTURE CONTROL ADJUSTMENTS	28
TO SET THE ON TIMER	30
TO SET THE OFF TIMER	31

PLAYBACK

LOADING AND UNLOADING A VIDEO CASSETTE	32
PLAYBACK	33
SPECIAL PLAYBACK	35

RECORDING

RECORDING A TV PROGRAM	37
INSTANT TIMER RECORDING (ITR)	39
TIMER RECORDING	40
OTHER FUNCTIONS FOR THE TIMER RECORDING	42

ADDITIONAL INFORMATION

USING THE REAL TIME TAPE COUNTER	44
USING ZERO RETURN	45
DUPLICATING A VIDEO TAPE	46
RECEPTION DISTURBANCES	47
TROUBLESHOOTING GUIDE	48
VIDEO HEAD CLEANING	50
SPECIFICATIONS	51

PRECAUTIONS

MOISTURE CONDENSATION

DO NOT OPERATE ANY FUNCTIONS ON THIS UNIT FOR AT LEAST TWO OR THREE HOURS WHEN MOISTURE IN THE AIR CONDENSES ON IT. LET THE UNIT STAND WITH POWER ON (SEE BELOW).

■ WHAT IS MOISTURE CONDENSATION?

When a cold liquid is poured into a glass, for example, water vapor in the air will condense on the surface of the glass. This is called moisture condensation.

■ MOISTURE WILL CONDENSE ON THE UNIT IN THE FOLLOWING CASES;

- When you move the unit from a cold to a warm place.
- After heating a cold room or under extremely humid conditions.

■ WHEN YOU EXPERIENCE THE ABOVE CONDITIONS,

Plug the power cord into an AC outlet, set the POWER switch to ON and leave the unit at room temperature until moisture condensation disappears.

Depending on the surrounding conditions, this may take two or three hours.

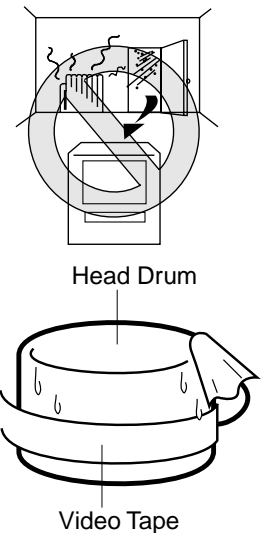

If you cause a static discharge when touching the unit, and the unit fails to function, simply unplug the unit from the wall outlet, wait a few minutes, and plug it back in. The unit should return to normal operation.

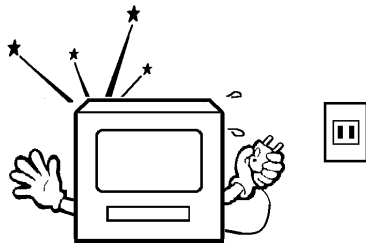

Avoid extreme heat.

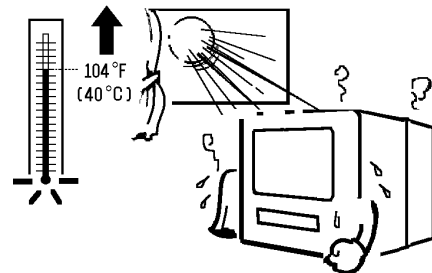

Do not place the unit on or near appliances which may cause electromagnetic interference (e.g. speakers, etc). Doing so may cause erratic operation of the unit including picture and/or sound distortion or noise.

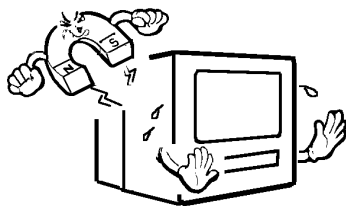

Avoid extreme cold.

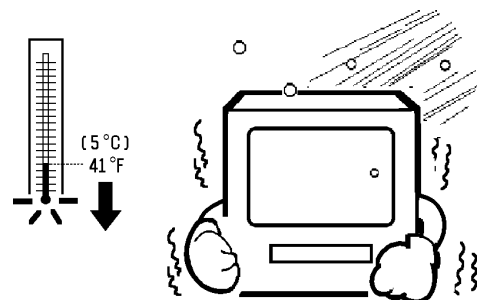

Avoid extreme moisture and dust.

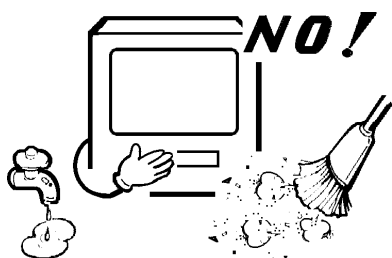

The ventilation holes prevent overheating. Do not block or cover these holes. Especially avoid covering the holes with soft materials such as cloth or paper.

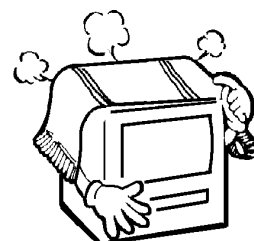

Do not insert fingers or any other objects into the cassette loading slot. Do not spray cleaner or wax directly on the unit or use forced air to remove dust.

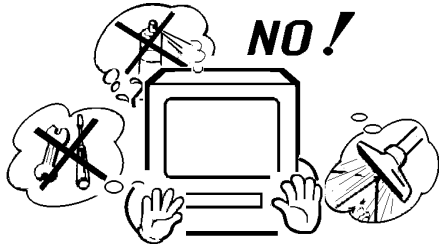

Avoid places subject to strong vibration. Use in a horizontal (flat) position only.

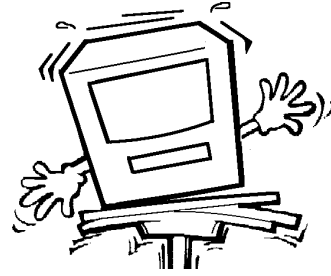

Keep the unit away from flower vases, sinks, etc. If liquids should be spilled into the unit, serious damage will result. If you spill any liquids into the unit, unplug the AC power cord immediately and consult qualified service personnel before attempting to use it again.



When you finish operating the unit, always unload the cassette and turn off the power.

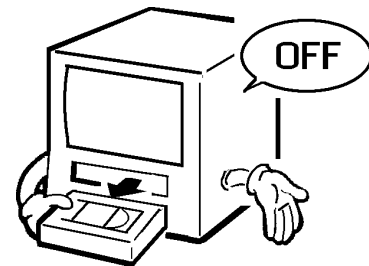

When you leave your home for a long time, unplug the AC power cord.

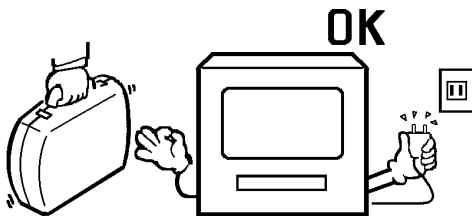

To protect the unit from a lightning storm, unplug the AC power cord from the wall outlet and disconnect the antenna.

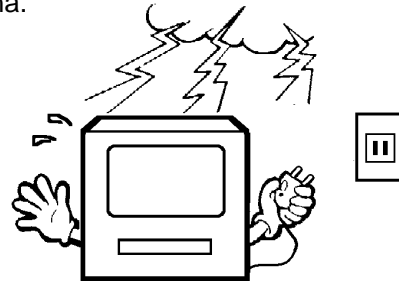

POWER SOURCE

TO USE AC POWER SOURCE

Use the AC polarized line cord provided for operation on AC. Insert the AC cord plug into a standard 120V 60Hz polarized AC outlet.

NOTES:

1. Never connect the AC line cord plug to other than the specified voltage (120V 60Hz). Use the attached power cord only.
2. If the polarized AC cord does not fit into a non-polarized AC outlet, do not attempt to file or cut the blade. It is the user's responsibility to have an electrician replace the obsolete outlet.
3. If you cause a static discharge when touching the unit, and the unit fails to function, simply unplug the unit, from the AC outlet, wait a few minutes, and plug it back in. The unit should return to normal operation.

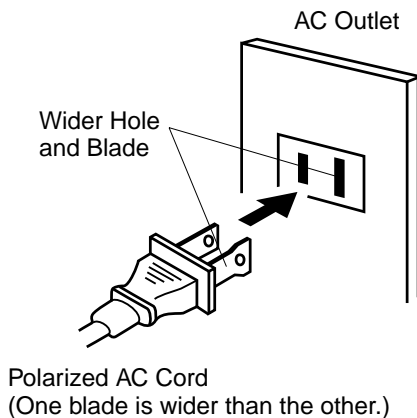

LOCATION OF CONTROLS

FRONT

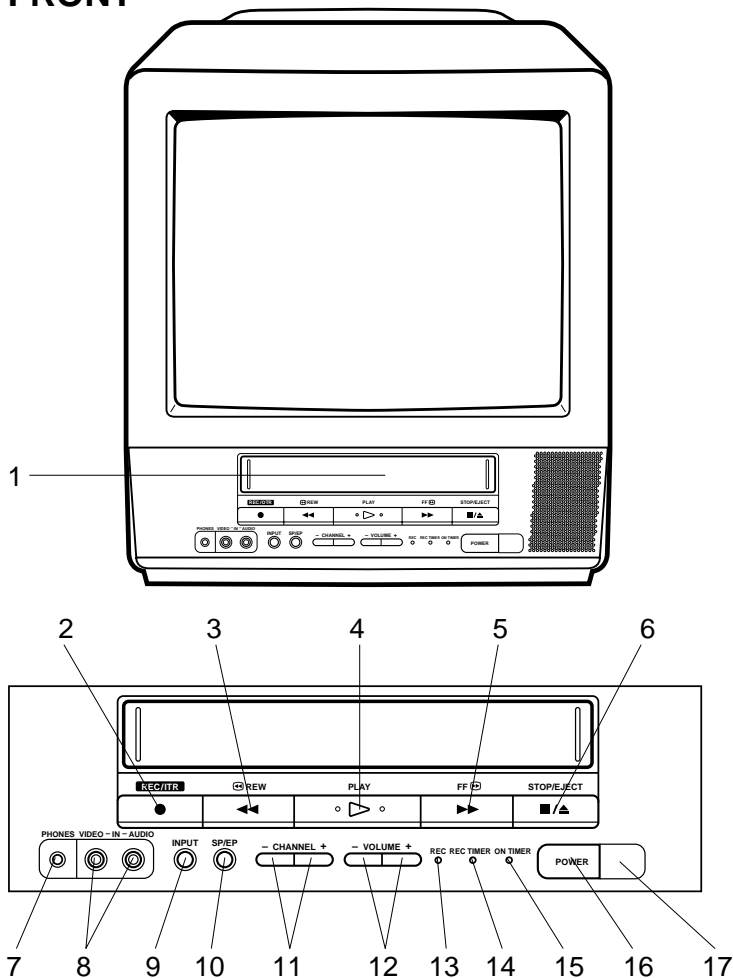

REAR

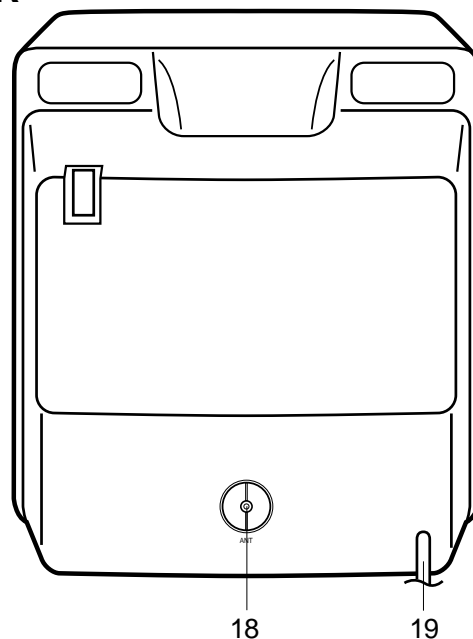

DESCRIPTION OF CONTROLS

FRONT:

- 1. Cassette Loading Slot** - To insert or remove a video tape.
- 2. REC/ITR Button** - Press once to start normal recording. Additional presses activate Instant Timer Recording.
- 3. REW (Rewind) Button** - In the Stop mode, this button rapidly winds the tape backwards. In the Play mode, this button activates reverse search.
- 4. PLAY Button** - Press to play a prerecorded tape.
- 5. FF (Fast Forward) Button** - In the Stop mode, this button rapidly winds the tape forward. In the Play mode, this button activates forward search.
- 6. STOP/EJECT Button** - Press once to stop the tape in any mode. Press again to eject the tape.
- 7. Headphone Jack** - Plug monaural headphones or an earphone with an 1/8" miniplug into this jack for private listening.
- 8. AUDIO/VIDEO IN Jacks** - Audio and video signal cables from an external source can be connected here.
- 9. INPUT Selector Button** - Switches the program for viewing between the VCR and an external input source.
- 10. SP/EP Selector Button** - Sets the tape speed for recording.
- 11. CHANNEL + / - Buttons** - Press to select a channel for viewing or recording.
- 12. VOLUME + / - Buttons** - Press to raise or lower the volume of the sound.
- 13. REC Indicator** - Lights when the TV/VCR is recording.
- 14. REC TIMER Indicator** - This lights when the TIMER button is pressed.
- 15. ON TIMER Indicator** - This indicator lights up when the powered up. It also lights up when **ON TIMER program** is turned ON while power is OFF.
- 16. POWER Button** - Press to turn the TV/VCR on or off.
- 17. Remote Sensor** - Signals from the Remote Control are received here.

REAR:

- 18. VHF/UHF Antenna Jack** - Connect the 75 ohm coaxial cable from the antenna or Cable TV service to this jack.
- 19. AC Power Cord** - Connect to a 120V, 60Hz outlet.

REMOTE CONTROL

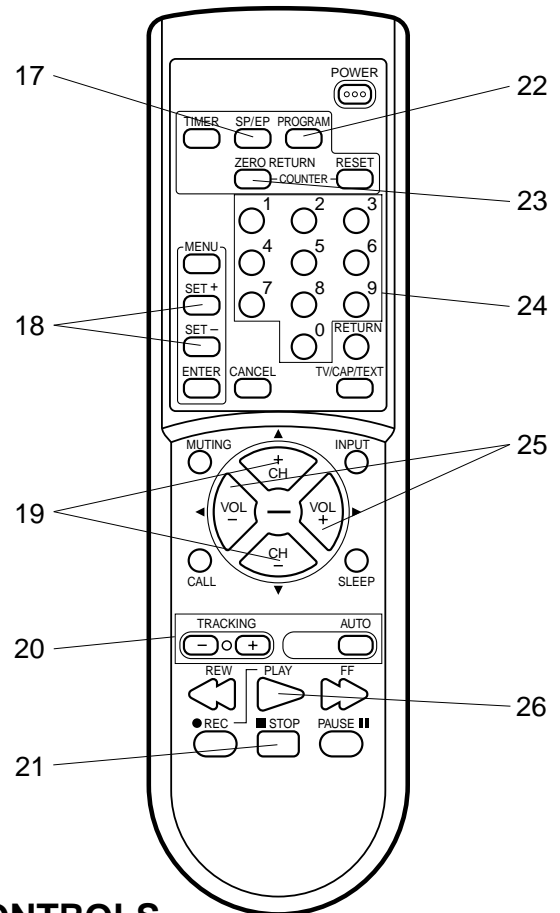
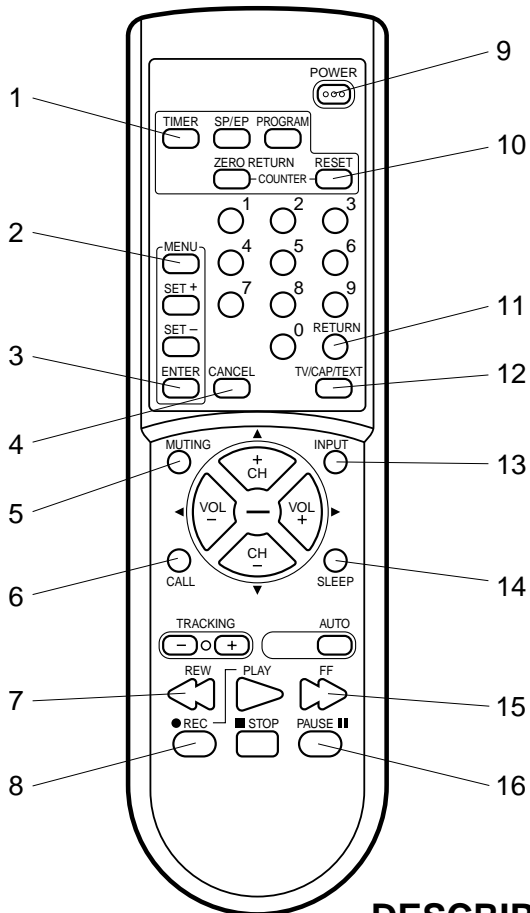

DESCRIPTION OF CONTROLS

1. **TIMER Button** - Used to set the TV/VCR to start recording at a preset time.
2. **MENU Button** - Press to display the On-Screen menu function.
3. **ENTER Button** - Press to enter selected setup.
4. **CANCEL Button** - Press to cancel existing setups or to restore default values.
5. **MUTING Button** - Press to turn off the sound. Press again to turn the sound back on.
6. **CALL Button** - Displays the present time/day of the week, channel, counter, speed selection (and VCR mode if VCR is playing) on the TV screen.
7. **REW (Rewind) Button** - In the Stop mode, this button rapidly winds the tape backwards. In the Play mode, this button activates reverse search.
8. **REC Button** - Press once together with the PLAY button to start normal recording. Additional presses activate Instant Timer Recording.
9. **POWER Button** - Press to turn the TV/VCR on. Press again to turn the TV/VCR off.
10. **COUNTER RESET Button** - Used to reset the counter to 00:00:00.
11. **RETURN Button** - Switches between the present channel and the last channel selected.
12. **TV/CAP/TEXT Button** - Switches between Caption, Text and TV modes for Closed-Captioned programs.
13. **INPUT Selector Button** - Switches the program for viewing between the VCR and external input sources.
14. **SLEEP Button** - Sets the TV to turn off automatically after up to 120 minutes.
15. **FF (Fast Forward) Button** - In the Stop mode, this button rapidly winds the tape forward. In the Play mode, this button activates forward search.
16. **PAUSE Button** - During recording, this button temporarily stops the tape. During playback, it stops the tape and displays a still image on the TV screen.
17. **SP/EP Selector Button** - Sets the tape speed for recording.
18. **SET + / - Buttons** - Used to select the option in the menu or set timer recording, ON/OFF timer, channel set, picture adjustment, auto repeat, clock and language.
19. **CHANNEL + / - Buttons** - Press the + button to change to a higher numbered channel set into memory. Press the - button to change to a lower numbered channel set into memory.
20. **Digital AUTO TRACKING Buttons** - Allows automatic or manual adjustment of tracking to minimize picture noise during playback.
21. **STOP Button** - Press once to stop the tape.
22. **PROGRAM Button** - Press to confirm the programmed timer recording and ON/OFF timer.
23. **ZERO RETURN Button** - Use to stop the tape when the counter reaches 00:00:00.
24. **Direct Channel Selection Buttons (0-9)** - Allows direct access to any channel.
25. **VOLUME + / - Buttons** - Press the + button to increase, or the - button to decrease the volume level.
26. **PLAY Button** - Press to play a prerecorded tape.

BATTERY INSTALLATION

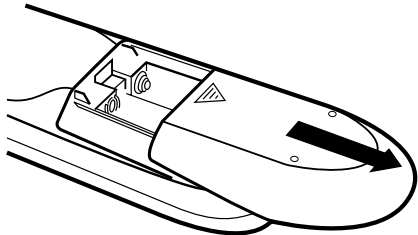
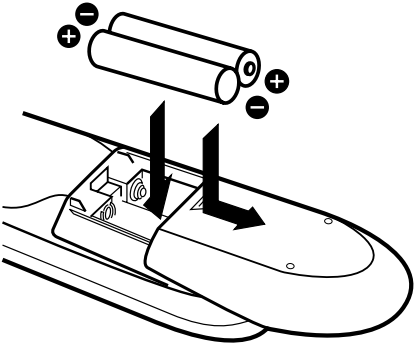
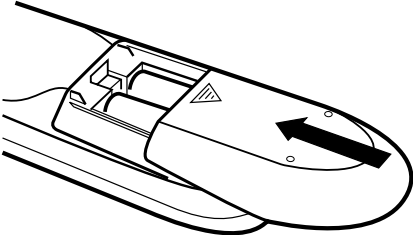
<p>1 Slide the battery compartment cover in the direction of the arrow.</p> 	<p>2 Install two "AA" (penlight size) batteries, paying attention to the polarity diagram in the battery compartment.</p> 	<p>3 Replace the compartment cover.</p> 
--	---	--

BATTERY PRECAUTIONS

The precautions below should be followed when using batteries in this device:

1. Use only the size and type of batteries specified.
2. Be sure to follow the correct polarity when installing the batteries as indicated in the battery compartment. Reversed batteries may cause damage to the device.
3. Do not mix different types of batteries together (e.g. Alkaline and Carbon-zinc) or old batteries with fresh ones.
4. If the device is not to be used for a long period of time, remove the batteries to prevent damage or injury from possible battery leakage.
5. Do not try to recharge batteries not intended to be recharged; they can overheat and rupture. (Follow battery manufacturer's directions.)

EFFECTIVE DISTANCE OF THE REMOTE CONTROL TRANSMITTER

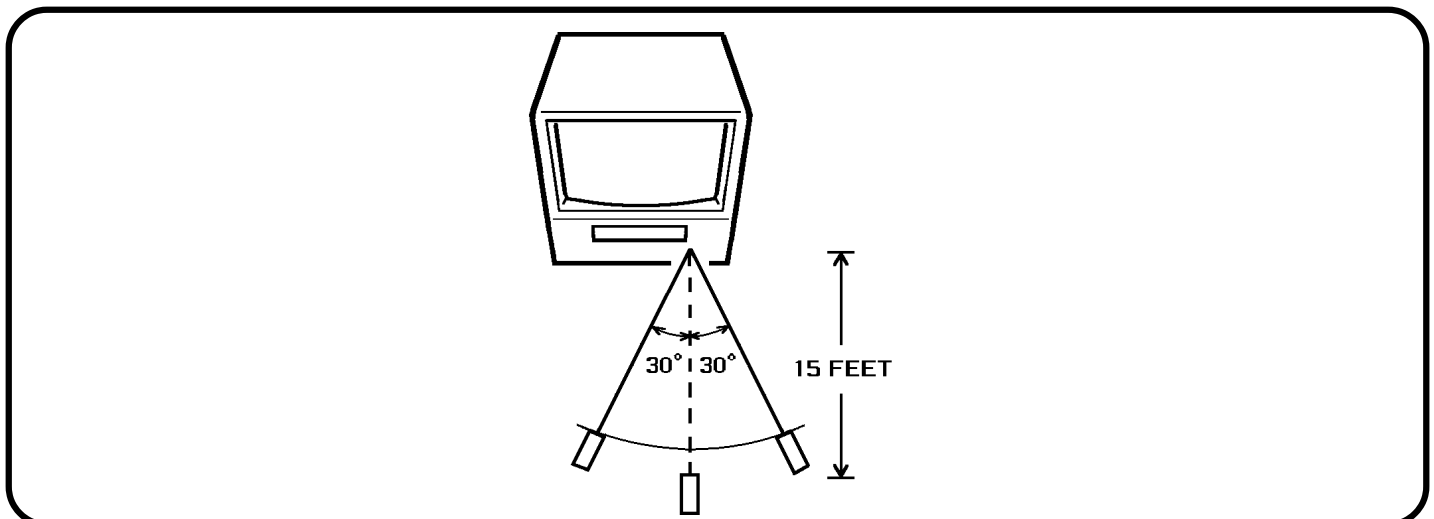

- NOTE:**
- When there is an obstacle between the TV/VCR and the transmitter, the transmitter may not operate.
 - When direct sunlight, an incandescent lamp, fluorescent lamp or any other strong light shines on the Remote sensor of the TV/VCR, the remote operation may be unstable.

ANTENNA CONNECTIONS

If you are using outdoor antenna (outdoor antenna not included), follow the instructions below that correspond to your antenna system. If you are using a cable TV service (CATV), see page 12 for Cable TV connections.

Combination VHF/UHF Antenna (Single 75 ohm cable or 300 ohm twin-lead wire)

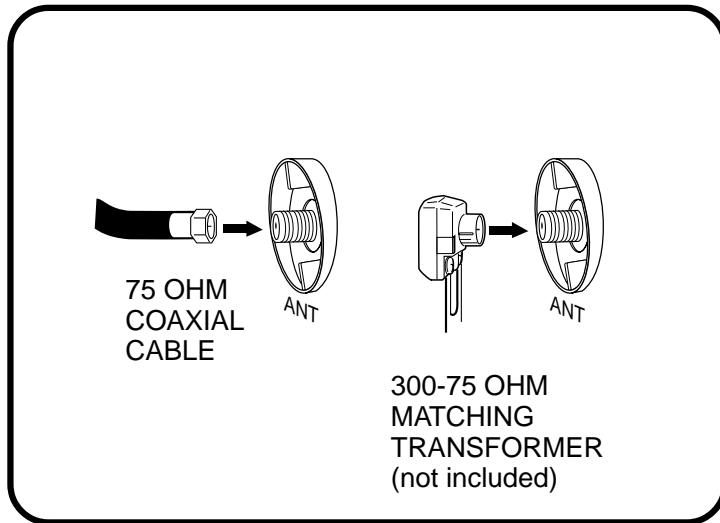

Connect the 75 ohm cable from the combination VHF/UHF antenna to the antenna jack.

If your combination VHF/UHF antenna has a 300 ohm twin-lead wire, the use of the 300-75 ohm matching transformer may be necessary.

Combination VHF/UHF Antenna (Separate VHF and UHF 300 ohm twin-lead wires)

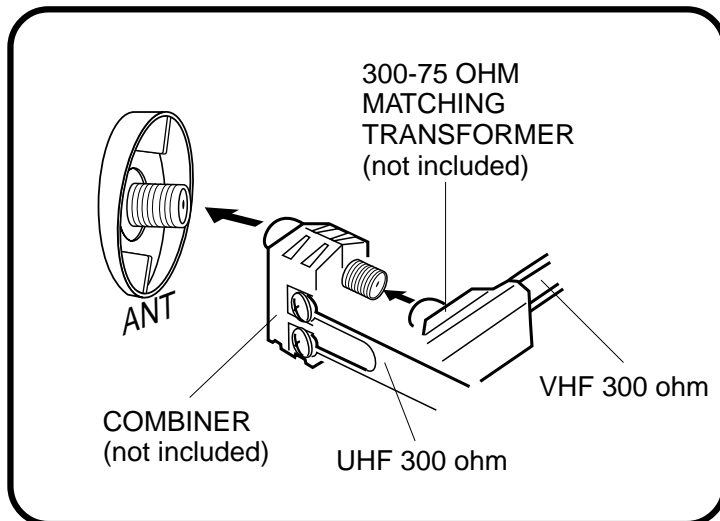

Connect the UHF 300 ohm twin-lead wire to the combiner (not supplied). Connect the VHF 300 ohm twin-lead wire to the 300-75 ohm matching transformer. Attach the transformer to the combiner, then attach the combiner to the antenna jack.

Separate VHF/UHF Antennas (75 ohm VHF cable and 300 ohm UHF twin-lead wires)

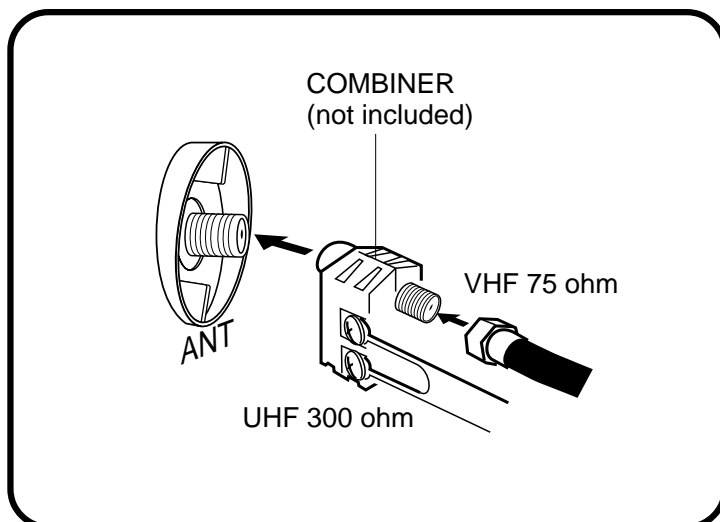

Connect the VHF 75 ohm cable and UHF 300 ohm twin-lead wire to the combiner. Attach the combiner to the antenna jack.

CABLE TV CONNECTIONS

This TV/VCR has an extended tuning range and can tune most cable channels without using a Cable TV converter box. Some cable companies offer "premium pay channels" in which the signal is scrambled. Descrambling these signals for normal viewing requires the use of a descrambler device which is generally provided by the cable company.

FOR SUBSCRIBERS TO BASIC CABLE TV SERVICE

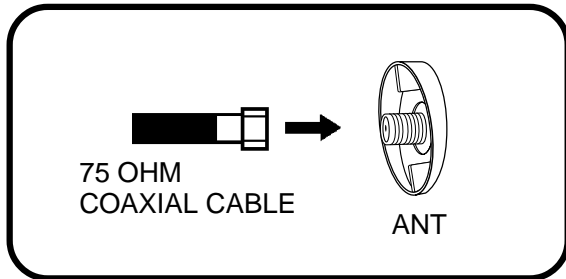

For basic cable service not requiring a converter/descrambler box, connect the CATV 75 ohm coaxial cable directly to the antenna jack on the back of the TV/VCR.

FOR SUBSCRIBERS TO SCRAMBLED CABLE TV SERVICE

If you subscribe to a cable TV service which requires the use of a converter/descrambler box, connect the incoming 75 ohm coaxial cable to the converter/descrambler box. Using another 75 ohm coaxial cable, connect the output jack of the converter/descrambler box to the antenna jack on the TV/VCR. Follow the connections shown below. Set the TV/VCR to the output channel of the converter/descrambler box (usually channel 3 or 4) and use the converter/descrambler box to select channels.

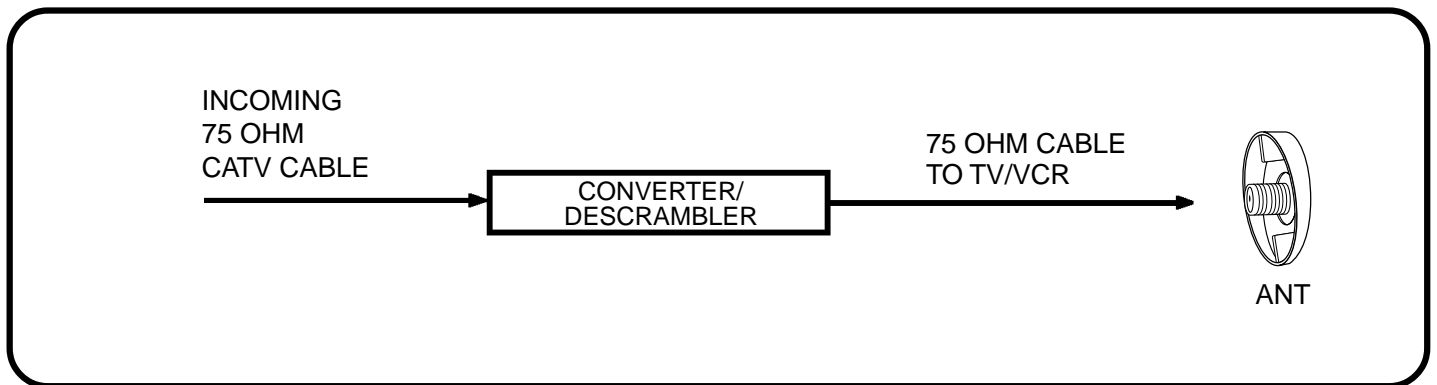

FOR SUBSCRIBERS TO UNSCRAMBLED BASIC CABLE TV SERVICE WITH SCRAMBLED PREMIUM CHANNELS

If you subscribe to a cable TV service in which basic channels are unscrambled and premium channels require the use of a converter/descrambler box, you may wish to use a signal splitter and an A/B switch box (available from the Cable company or an electronics supply store). Follow the connections shown below. With the switch in the "B" position, you can directly tune any nonscrambled channels on your TV/VCR. With the switch in the "A" position, tune your TV/VCR to the output of the converter/descrambler box (usually channel 3 or 4) and use the converter/descrambler box to tune scrambled channels.

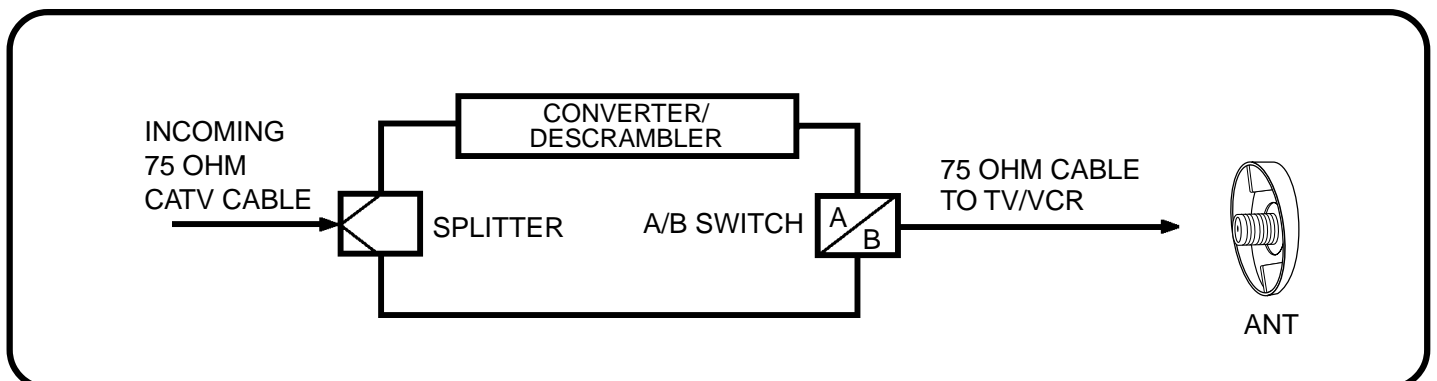

SETTING LANGUAGE

This TV/VCR can display the on screen language in English, Spanish or French.

Language selection (step 3) will automatically appear on the screen when you press the MENU button initially. Select language to use the other menu options.

1 Press the MENU button.
Press the SET + or – button to select the SYSTEM SET-UP option, then press the ENTER button.

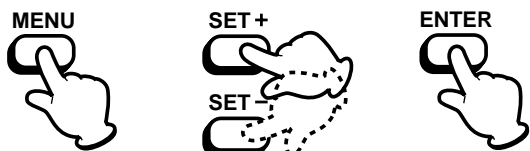

• If you press the MENU button before the clock is not set, SYSTEM SET-UP screen will appear. See step 2 in this case.

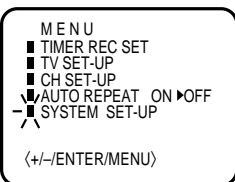

2 Press the SET + or – button to select the LANGUAGE option, then press the ENTER button.

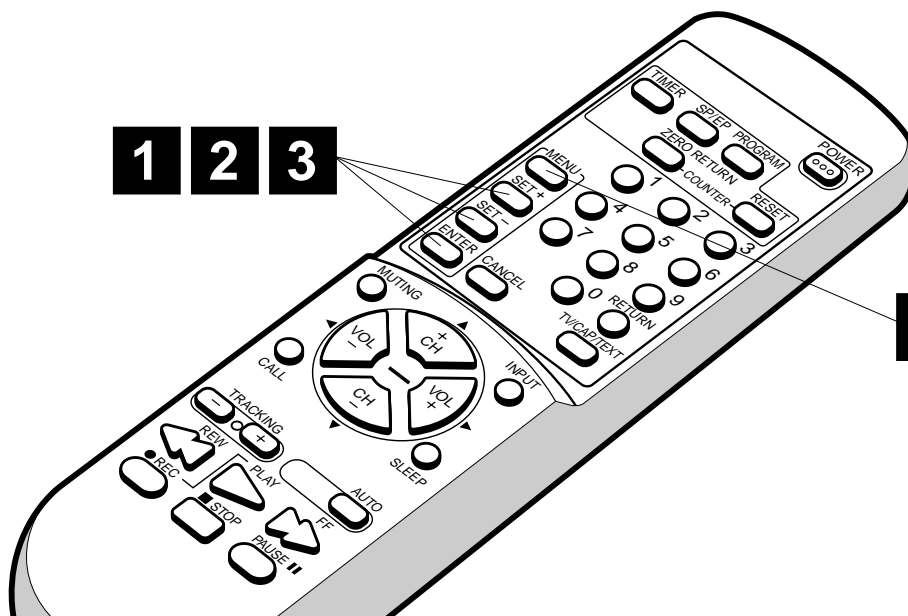
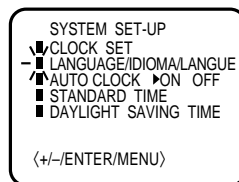

3 Press the SET + or – button to select the desired language: English (ENGLISH), Spanish (ESPAÑOL) or French (FRANCAIS), then press the ENTER button.

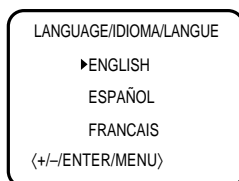

4 Press the MENU button twice to return to normal TV viewing.



AUTO CLOCK SETTING

The Auto Clock feature enables the automatic clock setting and updating, and also to set the Time Zone and Daylight Saving Time by receiving XDS (Extended Data Service) information carried on the channel signal.

You must set the antenna connection before the AC cord plug is inserted into the AC outlet.

AUTO CLOCK SETTING

1 **WAIT 30 MINUTES!** when the power switch is off, after the connections of the antenna and the power plug. Because the Auto Clock setting feature is activate. After the clock is set automatically, you may have to set the Time Zone and Daylight Saving Time. Press the POWER button to turn on the TV/VCR after the Auto Clock operation completed.



- When shipped from factory, the AUTO CLOCK option is set to AUTO position.
- If you turn the TV/VCR on in Auto Clock setting, the clock is not set.
- With cable box connection, if the Auto Clock Setting is unsuccessful, please select the PBS channel carrying the XDS information, then turn the TV/VCR off. After 30 minutes, turn the TV/VCR on, and if the clock is not set automatically, set the clock manually. (See page 16.)

Canadian Viewers:

Please see note regarding the AUTO CLOCK SETTING option on page 50.

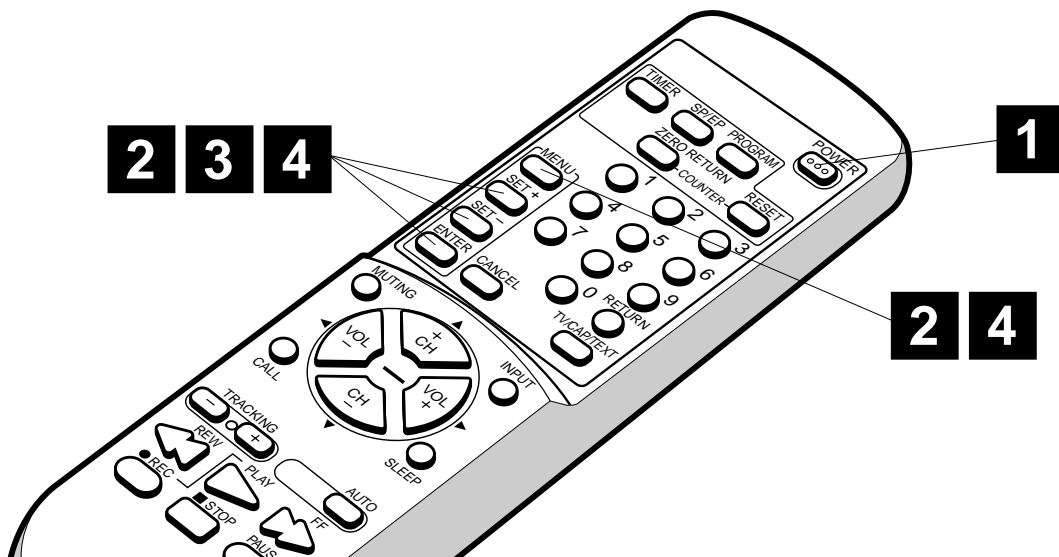

TIME ZONE SETTING (STANDARD TIME)

2 Press the MENU button. Press the SET + or – button to select the SYSTEM SET-UP option, then press the ENTER button.

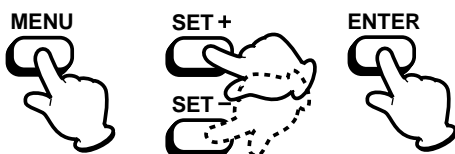

```

MENU
  [ ] TIMER REC SET
  [ ] TV SET-UP
  [ ] CH SET-UP
  [ ] AUTO REPEAT ON/OFF
  [ ] SYSTEM SET-UP
  (<+/-/ENTER/MENU)
    
```

3 Press the SET + or – button to select the STANDARD TIME option, then press the ENTER button.



```

SYSTEM SET-UP
  [ ] CLOCK SET
  [ ] LANGUAGE/DIOMA/LANGUE
  [ ] AUTO CLOCK ON/OFF
  [ ] STANDARD TIME
  [ ] DAYLIGHT SAVING TIME
  (<+/-/ENTER/MENU)
    
```

4 Using the SET + or – button, select your Time Zone, then press the ENTER button. Press the MENU button until the MENU screen is cleared.

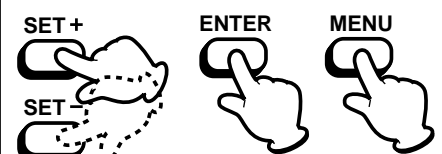

```

STANDARD TIME
  ATLANTIC          EASTERN
  CENTRAL          MOUNTAIN
  PACIFIC           ALASKA
  HAWAII
  AUTO
  (<+/-/ENTER/MENU)
    
```

NOTE: • After Auto Clock setting, in some case the clock may display the other time zone's. You can correct the clock by selecting your Time Zone setting above.

• When the clock is not set or you set the clock manually, Time Zone setting is not available.

DAYLIGHT SAVING TIME SETTING

You can set the Daylight saving time automatically or manually.

- 1** Press the MENU button. Press the SET + or – button to select the SYSTEM SET-UP option, then press the ENTER button.

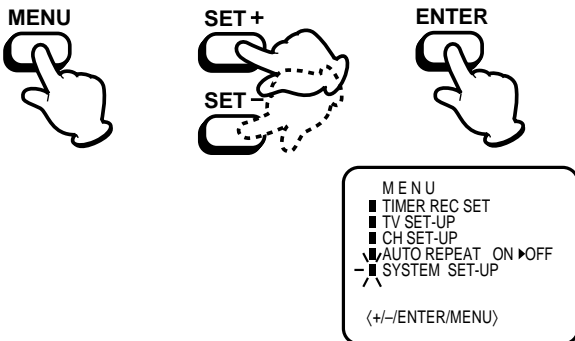

- 2** Press the SET + or – button to select the DAYLIGHT SAVING TIME option, then press the ENTER button.

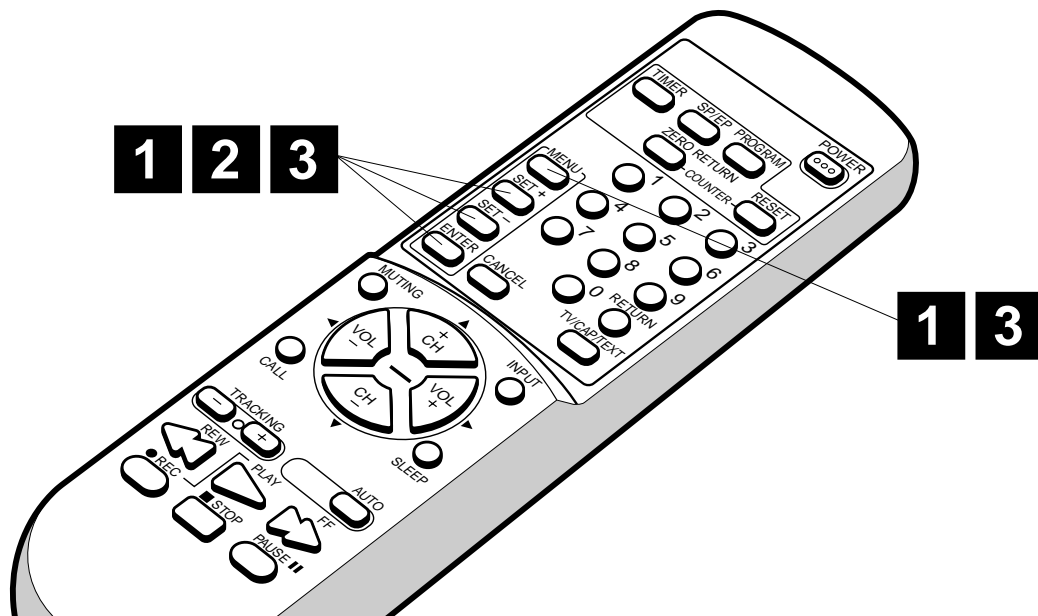
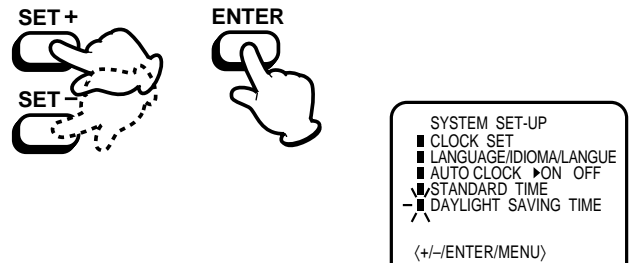

- 3** Press the SET + or – button to select one of the options, then press the ENTER button. Press the MENU button until the MENU screen is cleared.

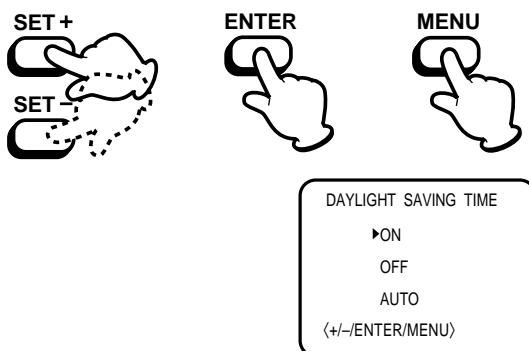

- ON:** for manual setting
(forward one hour)
- OFF:** for manual setting
(back one hour)
- AUTO:** for automatic setting
(read XDS in the signal)

When you want to set the Daylight Saving Time manually, on the first Sunday in April you set to "ON", and on the last Sunday in October you set to "OFF".

- NOTE:**
- When shipped from factory, the DAYLIGHT SAVING TIME option is set to AUTO position.
 - When the clock is not set, Daylight Saving Time setting is not available.
 - When there is no Daylight Saving Time in your area, always select OFF position in step 3.

MANUAL CLOCK SETTING

You must set the date and time manually for timer recordings, ON/OFF Timer and Daylight Saving Time if the Auto Clock process did not set them correctly.

EXAMPLE: Setting the clock to "8:30 AM", 23th (TUE) January, 2001.

1 Press the MENU button. Press the SET + or – button to select the SYSTEM SET-UP option, then press the ENTER button.

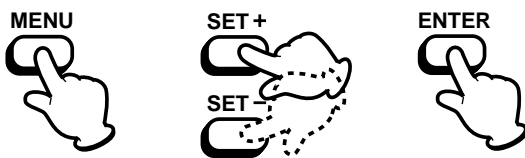

MENU

- TIMER REC SET
- TV SET-UP
- CH SET-UP
- AUTO REPEAT ON ▶ OFF
- SYSTEM SET-UP

<+/-/ENTER/MENU>

• If you press the MENU button before the clock is not set, SYSTEM SET-UP screen will appear. See step 2 in this case.

2 Press the SET + or – button to select the CLOCK SET option, then press the ENTER button.



- SYSTEM SET-UP
- CLOCK SET
- LANGUAGE/DIOM/LANGUE
- AUTO CLOCK ▶ ON OFF
- STANDARD TIME
- DAYLIGHT SAVING TIME

<+/-/ENTER/MENU>

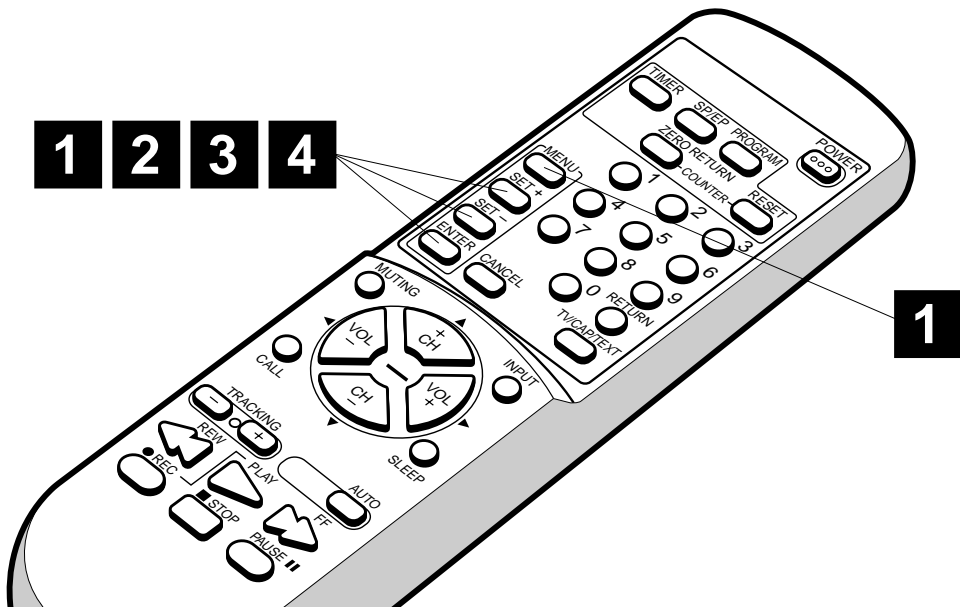

3 Press the SET + or – button to set the month, then press the ENTER button.



CLOCK SET

MONTH 1

DAY 23 (TUE)

YEAR 2000

TIME 12 : 00 AM

<+/-/ENTER/CANCEL/MENU>

4 Set the day, year and time as in step 3.



CLOCK SET

MONTH 1

DAY 23 (TUE)

YEAR 2000

TIME 8 : 30 AM

<+/-/ENTER/CANCEL/MENU>

After setting the clock, date and time starts functioning automatically.

8:30 AM TUE

NOTE:

- After a power failure or disconnection of the power plug, the time display will be lost. In this case, set the present time again if the Auto Clock did not set correctly.
- If you want to correct the digits while setting, press the CANCEL button until the item you want to correct, then press the SET+ or – button to correct the desired setting.

TV OPERATION

1 To turn on the TV/VCR, press the POWER button.

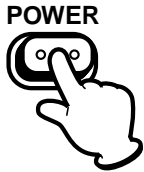

2 Adjust the volume level by pressing the VOLUME + or - button. The volume level will be indicated on the screen by green bar. As the volume level increases, so do the number of bar. If the volume decreases, the number of green bar also decreases.

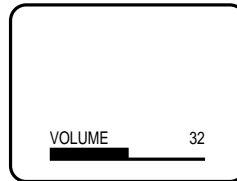
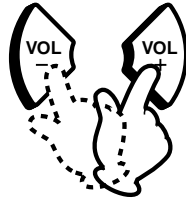

3 Set the TV/CATV menu option to the appropriate position. (See page 21.)

TV - VHF/UHF Channels
CATV - CABLE TV Channels

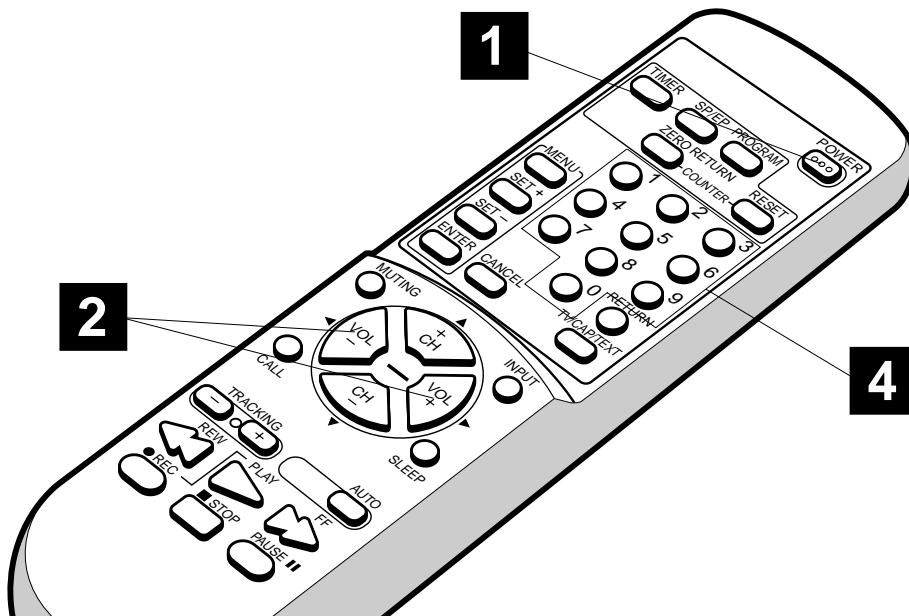

VHF/UHF/CATV CHANNELS

TV	CATV
VHF 2-13	VHF 2-13
UHF 14-69	STD/HRC/IRC 14-36 (A) (W) 37-59 (AA) (WW) 60-85 (AAA) (ZZZ) 86-94 (86) (94) 95-99 (A-5) (A-1) 100-125 (100) (125) 01 (5A)

4 Press the Direct Channel selection buttons to select the channel.
TV mode direct channel selection

When the TV/CATV menu option is in the TV position, all channels can be instantly selected by using two buttons. (for example, to select channel 2, press "0", then "2". If you press only "2", channel selection will be delayed for a few seconds.) For channels 10 and above, press the 2 digits in order.

CATV mode direct channel selection

When the TV/CATV menu option is in the CATV position, channels can be selected as follows:

TO SELECT CATV CHANNELS:

- 1-9 Press "0" twice, then 1-9 as needed. Example, to select channel 2, press "002".
- 10-12 Press "0", then the remaining 2 digits. Example, to select channel 12, press "012".
- 13-99 Press the 2 digits in order. Example, to select channel 36, press "36".
- 100-125 Press the 3 digits in order. Example, to select channel 120, press "120".

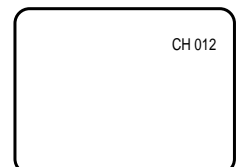
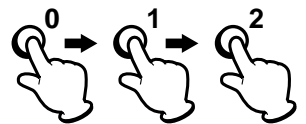

NOTE FOR CHANNELS 1-12:

If only 1 or 2 buttons are pressed, the corresponding channel will be selected in 2 seconds.

- NOTE:**
- If a channel with no broadcast is selected, the sound will automatically be muted.
 - If a station being viewed stops broadcasting, the TV will automatically shut itself off after 15 minutes.

MUTING

Press this button to turn off the sound. The TV/VCR's sound will be silenced and "MUTING" will briefly appear on the screen. The sound can be turned back on by pressing this button again or one of the VOLUME + or - buttons.

MUTING

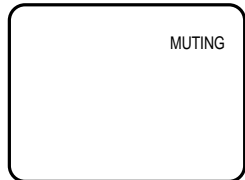

CHANNEL + AND -

Press and release the CHANNEL + or - button. The channel automatically stops at the next channel set into memory. For proper operation, before selecting channels, they should be set into the memory. See pages 21 and 22 "To memorize channels".

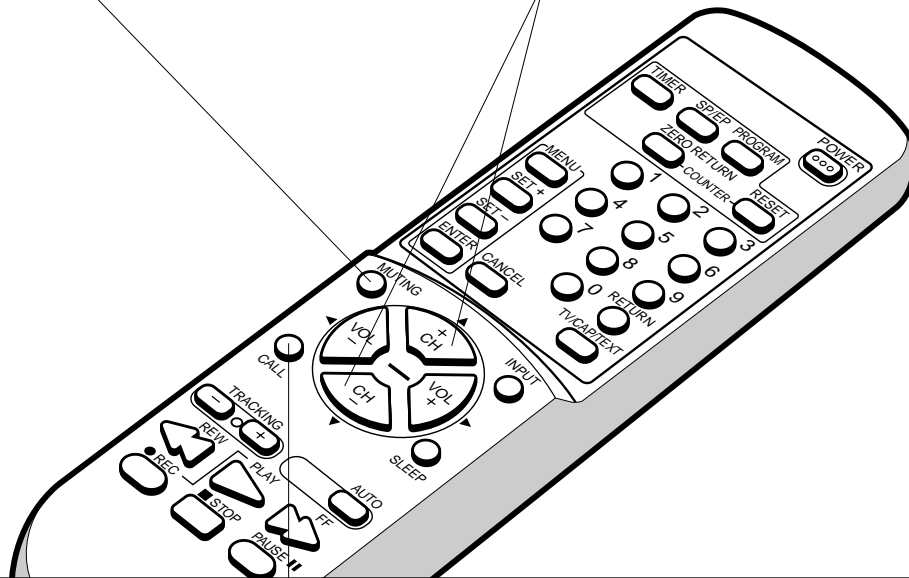
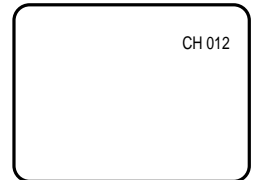
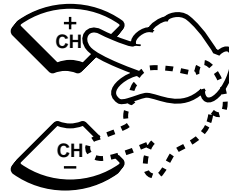

CALL

Press the CALL button. The clock, date, channel number, real time tape counter, tape speed and VCR operation will be indicated. Press CALL button again to disappear the call display.

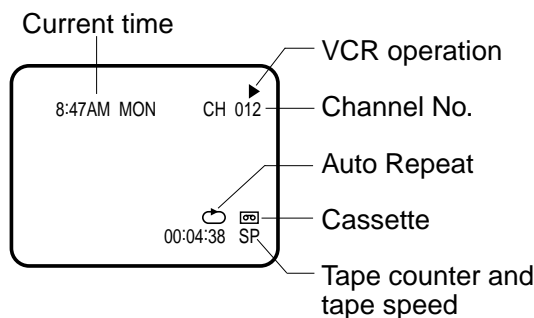

VCR operation

- : Play
- : Rewind
- : Fast-forward
- : Eject
- : Recording
- : Recording pause
- : Stop

NOTE: The Auto Repeat mark appears when Auto Repeat is selected.

To listen through the headphone, insert a headphone (not supplied) with a 1/8" mini plug into PHONES jack on the front. The sound from the TV speaker is muted.

SLEEP

To set the TV/VCR to turn off after a preset amount of time, press the SLEEP button on the remote control. The clock will count down 10 minutes for each press of the SLEEP button (120, 110, ...10, 0). After the sleep time is programmed, the display will appear briefly every ten minutes to remind you that the sleep timer is operating. To confirm the sleep timer setting, press the SLEEP button and the remaining time will be momentarily displayed. To cancel the sleep timer, press the SLEEP button repeatedly until the display turns to 0.

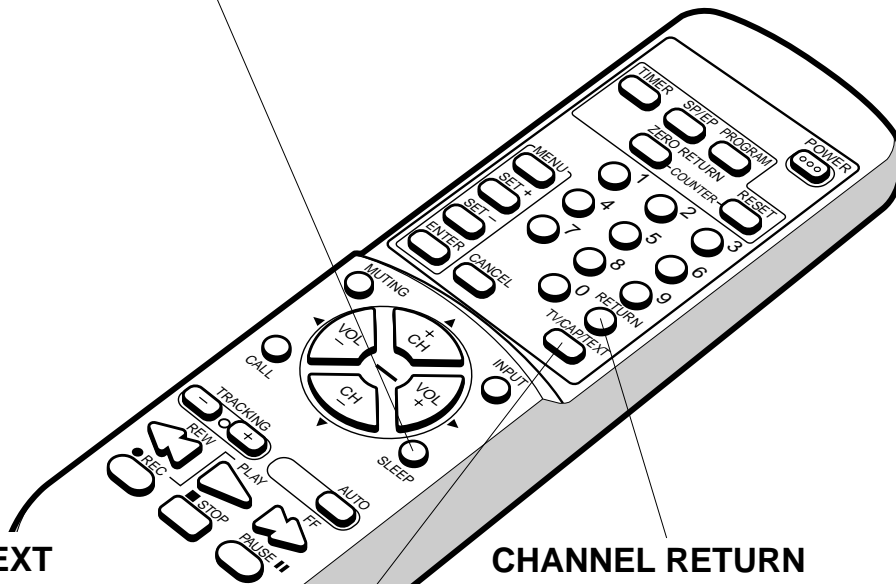
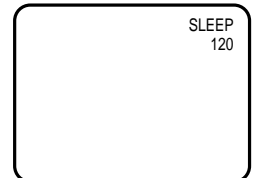

TV/CAPTION/TEXT

Press this button to switch between normal TV and the two closed caption modes (captions and full screen text). Closed captioning will display text on the screen for hearing impaired viewers.

TV/CAP/TEXT

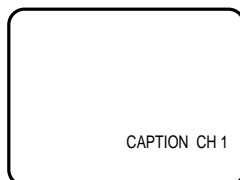

CHANNEL RETURN

This button allows you to go back to the last channel (or LINE) selected by pressing the RETURN button. Press this button again to return to the last channel (or LINE) you were watching.

RETURN

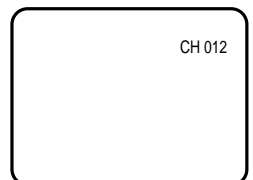

- NOTE:**
- If the station being viewed stops broadcasting, the TV will shut off after 15 minutes.
 - If using an indoor antenna or if TV reception is very poor, the Closed Caption Decoder text may not appear. In this case, adjust the antenna for better reception or use an outdoor antenna.
 - When activating the Closed Captioned Decoder, there will be a short delay before the Closed Captioned text appears on the screen.
 - Closed Captioned TV programs can be recorded and played back on a VCR with the Closed Captioned text intact. The Closed Captioning text will disappear during Cue, Rewind and Pause modes or if the VCR tracking is not adjusted properly.
 - Closed Captioned text is only displayed in locations where it is available.

WHAT IS CLOSED CAPTIONING?

This television has the capability to decode and display Closed Captioned television programs. Closed Captioning will display text on the screen for hearing impaired viewers or it will translate and display text in another language.

CLOSED CAPTIONING WITH A VCR

Closed Captioned programs can be recorded and played back on a VCR with the Closed Captioned text intact. The Closed Captioned text will disappear during Cue (Fast Forward Search), Review (Rewind Search) and Pause Modes or if the VCR tracking is not adjusted properly.

TO VIEW CLOSED CAPTIONS

Press the TV/CAP/TEXT button on the remote control to switch between normal TV and the two Closed Caption Modes (Captions and Full Screen Text).

Captions: This Closed Caption Mode will display text on the screen in English or another language (depending on the setting of the Closed Captions CH. Channel 1 or Channel 2).

Generally, Closed Captions in English are transmitted on Captions Channel 1 and Closed Captions in other languages are transmitted on Captions Channel 2.

Text: The Text Closed Caption Mode will usually fill the screen with a programming schedule or other information. After selecting a Closed Caption Mode, it will stay in effect until it is changed, even if the channel is changed. If the Captions signal is lost due to a commercial or a break in the signal, the Captions will reappear when the signal is received again.

If the channels are changed, the Captions will be delayed approximately 10 seconds.

The Captions will appear in places on the screen where they will least interfere with the picture, usually on the bottom of the screen. News programs will usually show three-line Closed Captions which scroll onto the screen. Most other shows provide two or three lined Captions placed near the character who is speaking so the viewer can follow the dialogue.

Words in italics or underlined describe titles, words in foreign languages or words requiring emphasis. Words that are sung usually appear enclosed by musical notes. For television programs broadcasting with Closed Captions, look in your TV guide for the Closed Captions symbol (CC).

- When selecting Closed Captions, the captioning will be delayed approximately 10 seconds.
- If no caption signal is received, no captions will appear, but the television will remain in the Caption Mode.
- Misspellings or unusual characters may occasionally appear during Closed Captioning. This is normal with Closed Captioning, especially with live programs. This is because during live programs, captions are also entered live. These transmissions do not allow time for editing.
- When the on-screen indicator appears during volume adjustment operation, etc., Closed Caption text will not be displayed.
- Some cable systems and copy protection systems may interfere with the Closed Captioned signal.
- If using an indoor antenna or if TV reception is very poor, the Closed Caption Decoder may not appear or may appear with strange characters or misspelled words. In this case, adjust the antenna for better reception or use an outdoor antenna.

TO MEMORIZE CHANNELS

This TV/VCR is equipped with a channel memory feature which allows channels to skip up or down to the next channel set into memory, skipping over unwanted channels. Before selecting channels, they must be programmed into the TV/VCR's memory. In addition to normal VHF and UHF channels, this TV/VCR can receive up to 113 Cable TV channels. To use this TV/VCR with an antenna, set the TV/CATV menu option to the TV mode. When shipped from the factory, this menu option is in the CATV mode.

TV/CATV SELECTION

1 Press the MENU button.

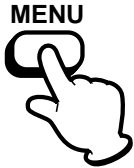

2 Press the SET + or – button to select the CH SET-UP mode, then press the ENTER button.



MENU
 ■ TIMER REC SET
 ▾ TV SET-UP
 ▸ CH SET-UP
 - CH SET-UP
 ▲ AUTO REPEAT ON ▸ OFF
 ■ SYSTEM SET-UP

<+/-ENTER/MENU>

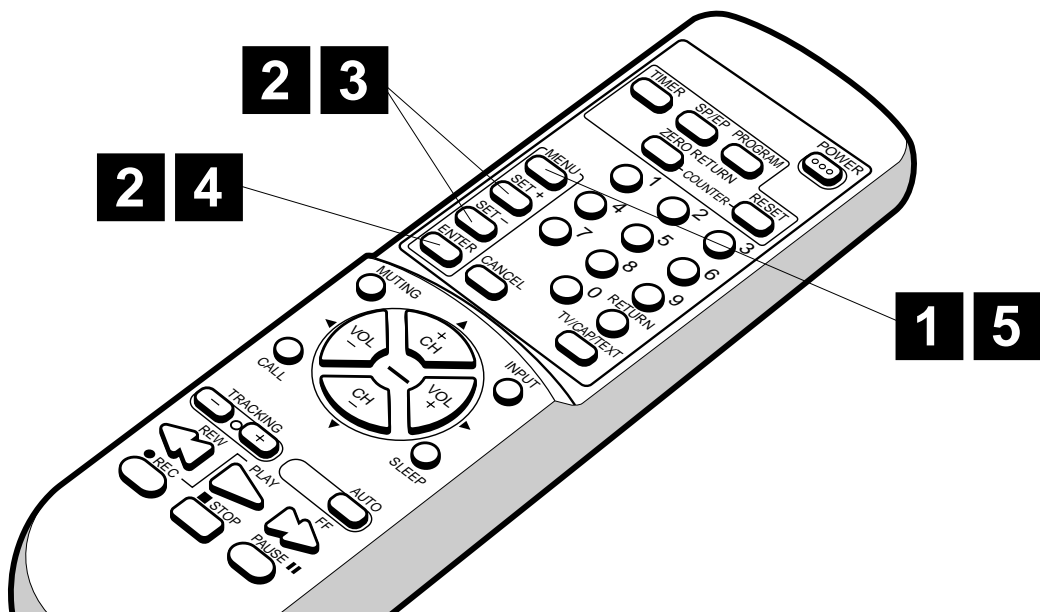

3 Press the SET + or – button to select the TV/CATV mode.

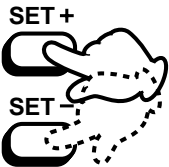

- CH SET-UP
 ▸ TV ▸ CATV
 ▸ AUTO CH MEMORY
 ■ ADD/DELETE

<+/-ENTER/MENU>

4 Press the ENTER button to select the TV or CATV mode. The arrow indicates the selected mode.



TV - VHF/UHF channels
 CATV - Cable TV channels

5 Press the MENU button until the MENU screen is cleared.



AUTOMATIC MEMORY TUNING

1 Press the MENU button.



2 Press the SET + or – button to select the CH SET-UP mode, then press the ENTER button.



MENU

- TIMER REC SET
- ▼ TV SET-UP
- CH SET-UP
- ▶ AUTO REPEAT ON ▶ OFF
- SYSTEM SET-UP

<+/-/ENTER/MENU>

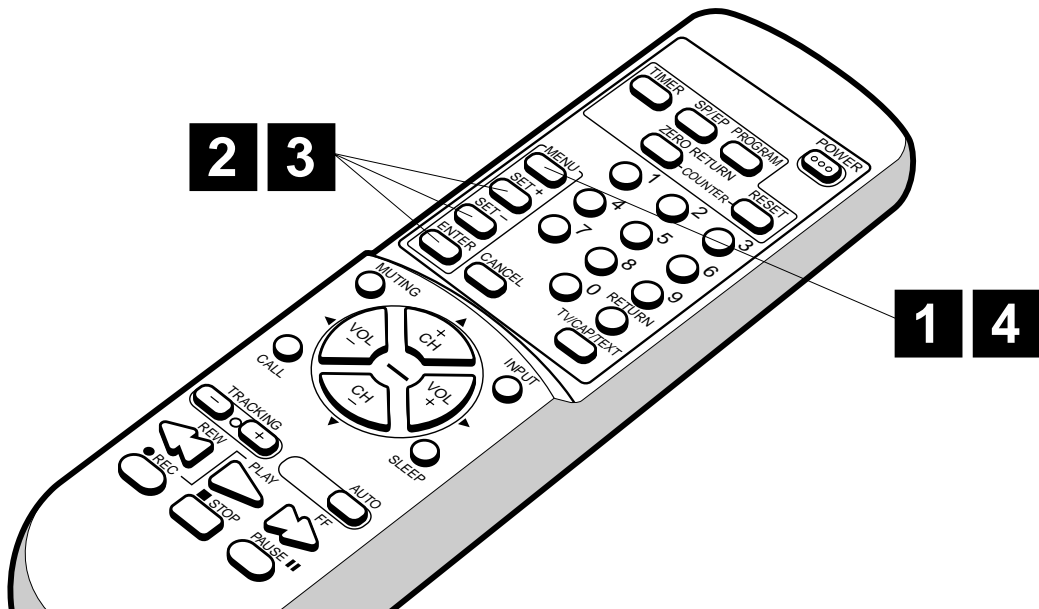

3 Press the SET + or – button to select the AUTO CH MEMORY mode, then press the ENTER button. The TV will begin memorizing all the channels available in your area.



CH SET-UP



- ▼ TV ▶ CATV
- AUTO CH MEMORY
- ▶ ADD/DELETE

<+/-/ENTER/MENU>

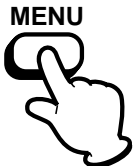

4 Press the MENU button until the MENU screen is cleared.

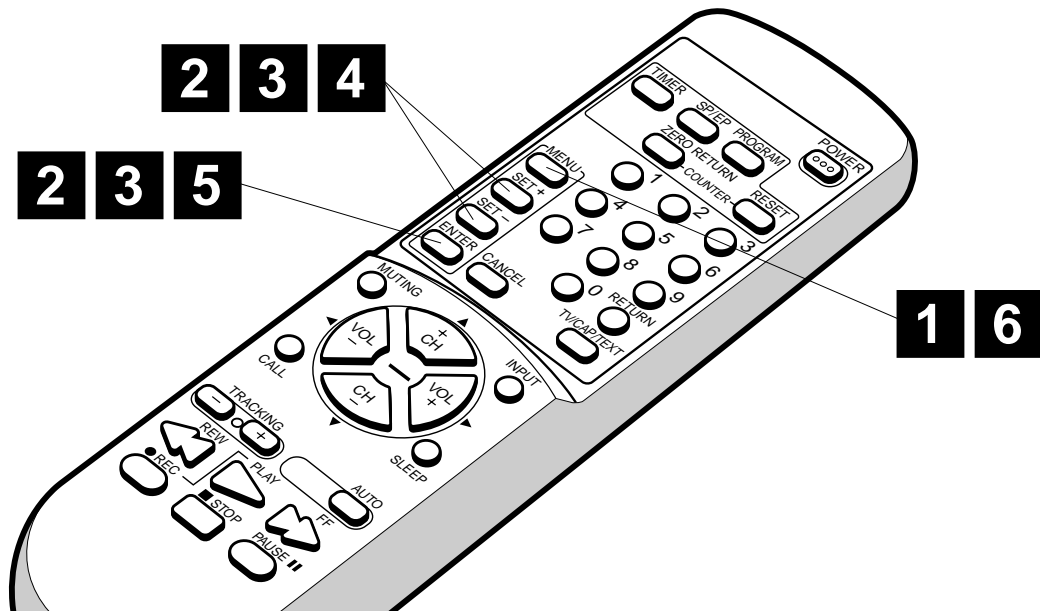

TO ADD/DELETE CHANNELS

<p>1 Press the MENU button.</p> 	<p>2 Press the SET + or – button to select the CH SET-UP mode, then press the ENTER button.</p>  <div data-bbox="766 604 1005 784" style="border: 1px solid black; padding: 5px;"> <p>M E N U</p> <ul style="list-style-type: none"> ■ T I M E R R E C S E T ▼ T V S E T - U P - C H S E T - U P ▲ A U T O R E P E A T O N ▶ O F F ■ S Y S T E M S E T - U P <p><+/-/ENTER/MENU></p> </div>	<p>3 Press the SET + or – button to select the ADD/DELETE mode, then press the ENTER button.</p>  <div data-bbox="1228 604 1468 784" style="border: 1px solid black; padding: 5px;"> <p>C H S E T - U P</p> <ul style="list-style-type: none"> ■ T V ▶ C A T V ▼ A U T O C H M E M O R Y - A D D / D E L E T E <p><+/-/ENTER/MENU></p> </div>
--	--	--

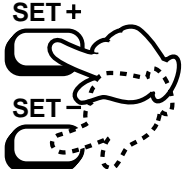

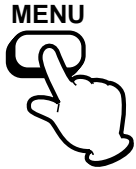
<p>4 Select the desired channel to be memorized or deleted using SET + or – button, or using the Direct Channel Selection buttons (10 keys, 0-9), or CHANNEL + or – button.</p> 	<p>5 Press the ENTER button to select the ADD or DELETE. If you select an unmemorized channel, the Channel indication will be red. If you select the ADD mode, the Channel indication changes from red to green and the channel will be memorized. If you select a memorized channel, the Channel indication will be green. If you select the DELETE mode, the Channel indication changes from green to red and the channel will be deleted from the memory.</p>  <div data-bbox="798 1803 1013 1960" style="border: 1px solid black; padding: 5px;"> <p>A D D C H 003</p> <p><0-9/+/-/ENTER/MENU></p> </div>	<p>6 Press the MENU button until the MENU screen is cleared.</p> 
--	--	---

SETTING THE V-CHIP

An age limitation can be set to forbid children to see and hear violent scenes or pictures for adults, etc. The TV/VCR responds to "TV RATING", "MOVIE RATING" and "CANADIAN RATING". To use the V-Chip function, you must register a password.

TO REGISTER PASSWORD

1 Press the MENU button.

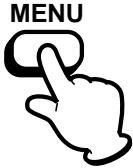

2 Press the SET + or – button to select the TV SET-UP option, then press the ENTER button.



MENU
 [TIMER REC SET]
 [TV SET-UP]
 [CH SET-UP]
 [AUTO REPEAT ON/OFF]
 [SYSTEM SET-UP]

<+/-/ENTER/MENU>

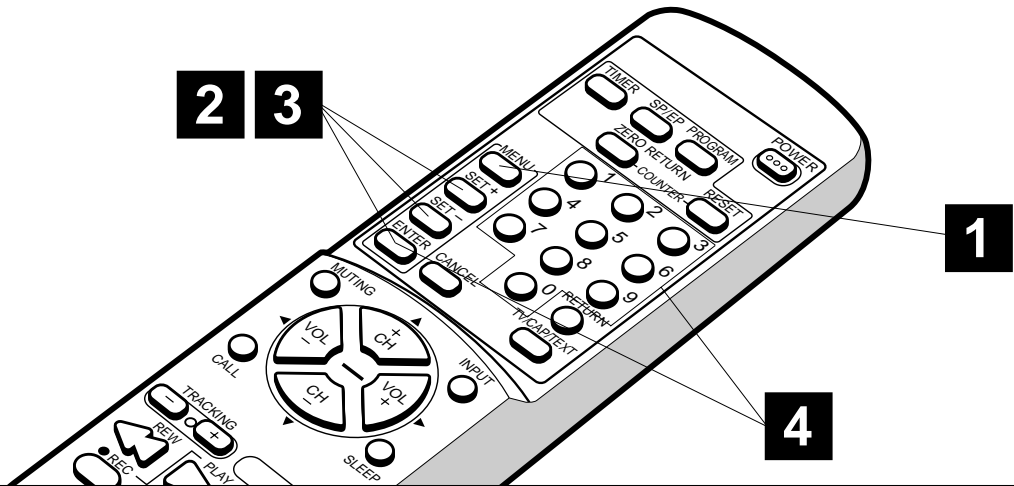

3 Press the SET + or – button to select the V-CHIP SET then press the ENTER button.



[TV SET-UP]
 [V-CHIP SET]
 [ON/OFF TIMER]
 [PICTURE]

<+/-/ENTER/MENU>

4 Enter the password (4 digits) using the Direct Channel Selection buttons (0-9), then press the ENTER button.

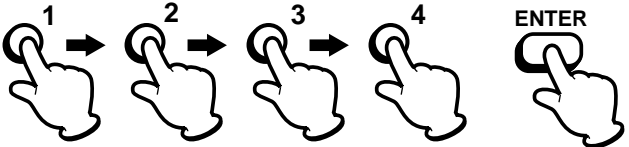

"*" appears instead of the number.
 If you enter the V-CHIP SET menu for the first time, the password set screen will appear to register a password. You must enter a new password for registration and confirmation.

V-CHIP SET
 PASSWORD: ****

<0-9/ENTER/CANCEL/MENU>

- NOTES:**
- If you forget the password, you cannot set the V-Chip.
 - To avoid forgetting the password, write it down and keep in a safe place.

TO SET THE V-CHIP

- 1** In the V-CHIP SET menu, press the SET + or – button to select the desired rating, then press the ENTER button.



V-CHIP SET	: OFF
V-CHIP	: OFF
US TV RATING	: OFF
MOVIE RATING	: OFF
CAN ENG RATING	: OFF
CAN FRE RATING	: OFF
CHANGE PASSWORD	
(<+/-/ENTER/MENU)	

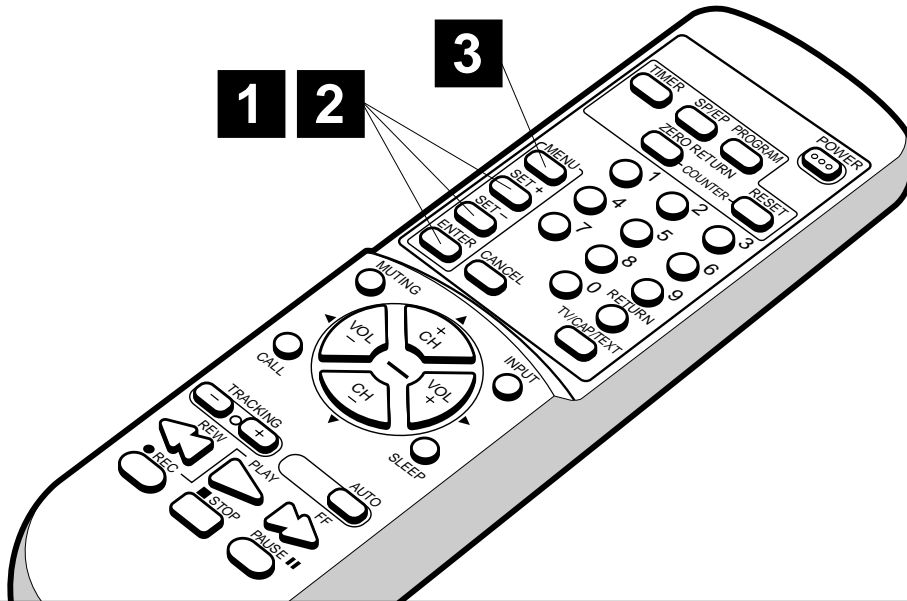

- 2** Press the SET + or – button to display the desired setting, then press the ENTER button.



V-CHIP SET	: OFF
V-CHIP	: OFF
US TV RATING	: TV-PG
MOVIE RATING	: OFF
CAN ENG RATING	: OFF
CAN FRE RATING	: OFF
CHANGE PASSWORD	
(<+/-/ENTER/MENU)	

- For further details of setting, see next page.

- 3** Press the MENU button until the MENU screen is cleared.

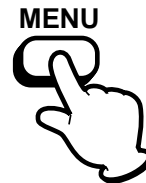

- NOTES:**
- The V-Chip function is activated only on programs and tapes that have the rating signal.
 - To activate the V-Chip function, select “V-CHIP” in the V-CHIP SET menu then press the ENTER button to select the “ON” position.

US TV RATING

- OFF** : US TV RATING is not set
- TV-Y** : All children
- TV-Y7** : 7 years old and above
- TV-G** : General Audience
- TV-PG** : Parental guidance
- TV-14** : 14 years old and above
- TV-MA** : 17 years old and above

• When you select TV- Y7, TV-PG, TV-14 or TV-MA, press the CALL button to show the contained rating. Press the SET + or – button to select the desired item you want. Press the ENTER button to select OFF. If you want to back to the V-CHIP SET menu, press the MENU button.

MOVIE RATING

- OFF** : MOVIE RATING is not set
- G** : All ages
- PG** : Parental guidance
- PG-13** : Parental guidance less than 13 years old
- R** : Under 17 years old
Parental guidance suggested
- NC17** : 17 years old and above
- X** : Adult only

CANADIAN ENGLISH RATING

E: Exempt

Exempt programming includes: news, sports, documentaries and other information programming, talk shows, music videos, and variety programming.

C: Programming Intended for Children

Violence Guidelines: There will be no realistic scenes of violence. Depictions of aggressive behavior will be infrequent and limited to portrayals that are clearly imaginary, comedic or unrealistic in nature.

C8+: Programming Intended for Children 8 and Over

Violence Guidelines: Any realistic depictions of violence will be infrequent, discreet, of low intensity and will show the consequences of the acts. There will be no offensive language, nudity or sexual content.

G: General Audience

Programming will contain little violence and will be sensitive to themes which could affect younger children.

PG: Parental Guidance

Programming intended for a general audience, but which may not be suitable for younger children. Parents may consider some content not appropriate for children aged 8-13.

14+: 14 Years and Older

Parents are strongly cautioned to exercise discretion in permitting viewing by pre-teens and early teens. Programming may contain mature themes and scenes of intense violence.

18+: Adult

Material intended for mature audiences only.

- For instructions on “CLASSIFICATION CANADIENNE FRANÇAISE” (in French), please see page 26 in the French side of this user’s guide.

TO CHANGE PASSWORD

1. Press the MENU button.
2. Press the SET + or – button to select the TV SET-UP, then press the ENTER button.
3. Press the SET + or – button to select the V-CHIP SET, then press the ENTER button.
4. Enter the Password using the Direct Channel Selection button (0-9), then press the ENTER button.
5. Press the SET + or – button to select CHANGE PASSWORD, then press the ENTER button.
6. Enter the new password using the Direct Channel Selection button (0-9), then press the ENTER button.
7. Enter the same password again for safety, then press the ENTER button.
8. Press the MENU button repeatedly to return to normal screen.

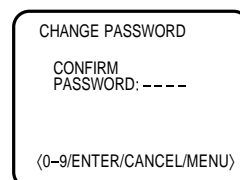
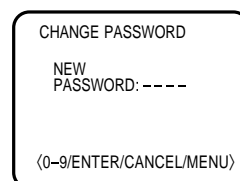
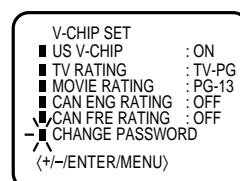
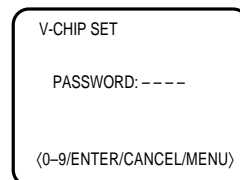
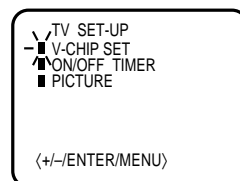
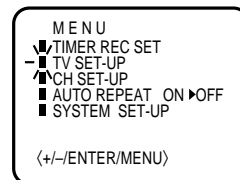

PICTURE CONTROL ADJUSTMENTS

Picture controls are factory preset but you can adjust them individually as follows:

1

To display the picture adjustment screen, press the MENU button.
Press the SET + or – button to select the TV SET-UP option, then press the ENTER button.

MENU



SET +
SET -

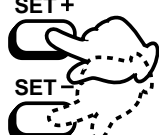

ENTER



MENU
 ▼ TIMER REC SET
 - TV SET-UP
 ▲ CH SET-UP
 ■ AUTO REPEAT ON ▶ OFF
 ■ SYSTEM SET-UP

(<+/-/ENTER/MENU)

2

Press the SET + or – button to select the PICTURE option, then press the ENTER button.

SET +
SET -



ENTER



TV SET-UP
 ■ V-CHIP SET
 ▼ ON/OFF TIMER
 - PICTURE

(<+/-/ENTER/MENU)

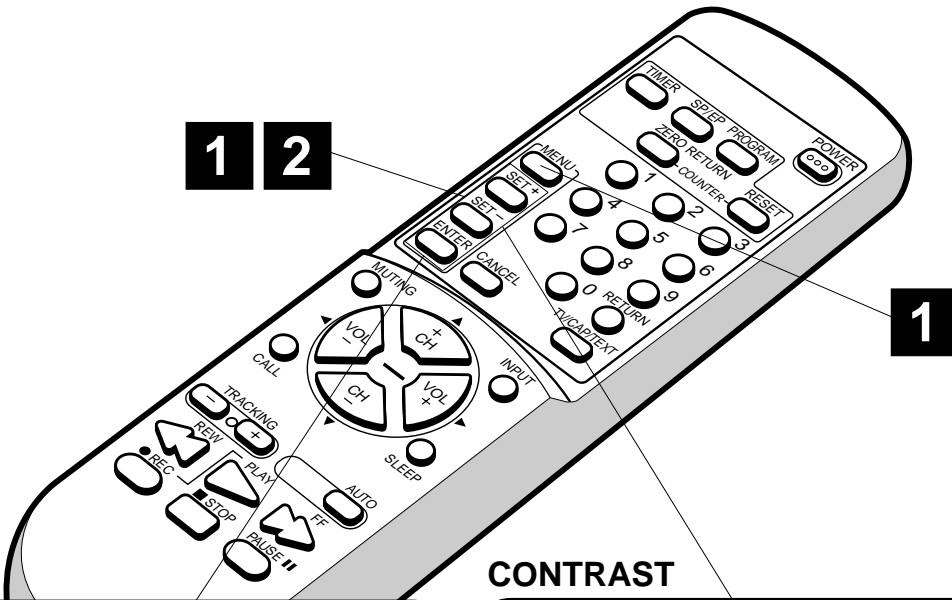

BRIGHTNESS

Press the ENTER button until "BRIGHTNESS" appears on the screen, then press the SET + or – button to adjust the brightness of the picture. When the SET + button is pressed, the darker portions of the picture become lighter.

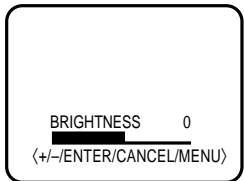
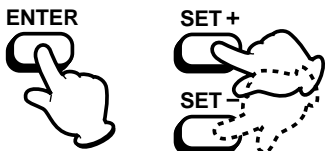

CONTRAST

Press the ENTER button until "CONTRAST" appears on the screen, then press the SET + or – button to adjust the contrast of the picture. Pictures look sharpest in the daytime (bright light) by increasing the contrast. At night (dim light), the sharpest picture is obtained by reducing the contrast.

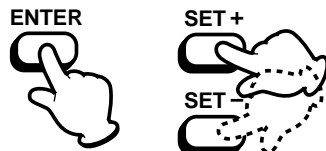

NOTE: The CONTRAST default setting is set to maximum at the factory.

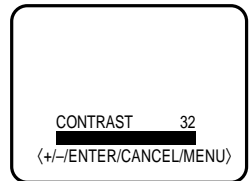

COLOR

Press the ENTER button until "COLOR" appears on the screen, then press the SET + or – button to adjust the color intensity of the picture. The control should be set when colors appear normal in intensity and brilliance.

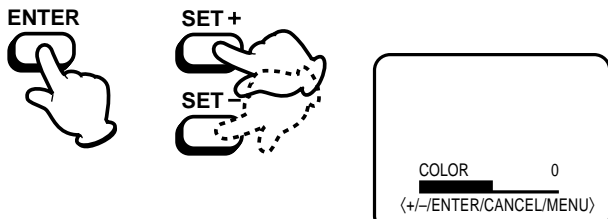

TINT

Press the ENTER button until "TINT" appears on the screen, then press the SET + or – button to adjust the tint of the picture. This determines how accurately the colors are reproduced by the TV. Adjusting the tint for natural facial tone is the best method of obtaining accurate color reproduction of the entire picture.

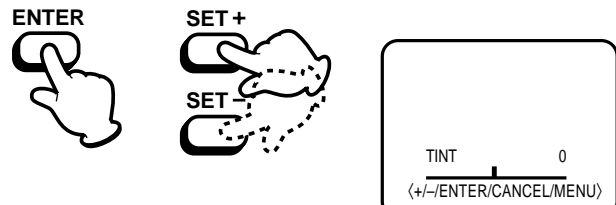

SHARPNESS

Press the ENTER button until "SHARPNESS" appears on the screen, then press the SET + or – button to adjust the sharpness of the picture.

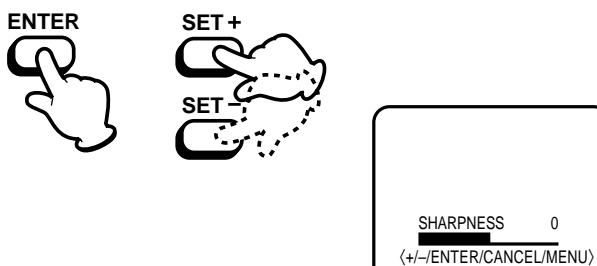

RESET PICTURES (CANCEL)

Pressing the CANCEL button while making picture adjustments will return all adjustments to the factory preset levels.



NOTE: The On-screen display will disappear 6 seconds after finishing an adjustment or by pressing the MENU button three times. The settings can only be adjusted when they are displayed on the TV screen.

TO SET THE ON TIMER

This feature allows you to have the TV automatically turn "ON" at predetermined time. If you program the "ON" timer once the timer will turn "ON" the TV daily at the same time and to the same channel.

EXAMPLE: Turning on the TV to channel 12 at 7:00 AM, MONDAY-FRIDAY.

1 Press the MENU button. Press the SET + or – button to select the TV SET-UP option, then press the ENTER button.

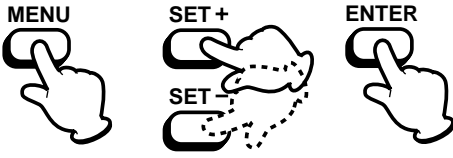

MENU
 - TIMER REC SET
 - TV SET-UP
 - CH SET-UP
 - AUTO REPEAT ON/OFF
 - SYSTEM SET-UP

(+/-)/ENTER/MENU

2 Press the SET + or – button to select the ON/OFF TIMER option, then press the ENTER button.



TV SET-UP
 - V-CHIP SET
 - ON/OFF TIMER
 - PICTURE

(+/-)/ENTER/MENU

3 Press the SET + or – button to select the ON TIMER option, then press the ENTER button.



ON/OFF TIMER
 - ON TIMER 12:00AM CH 012 CANCEL
 SUN-SAT
 - OFF TIMER 12:00AM CANCEL

(+/-)/ENTER/CANCEL/MENU

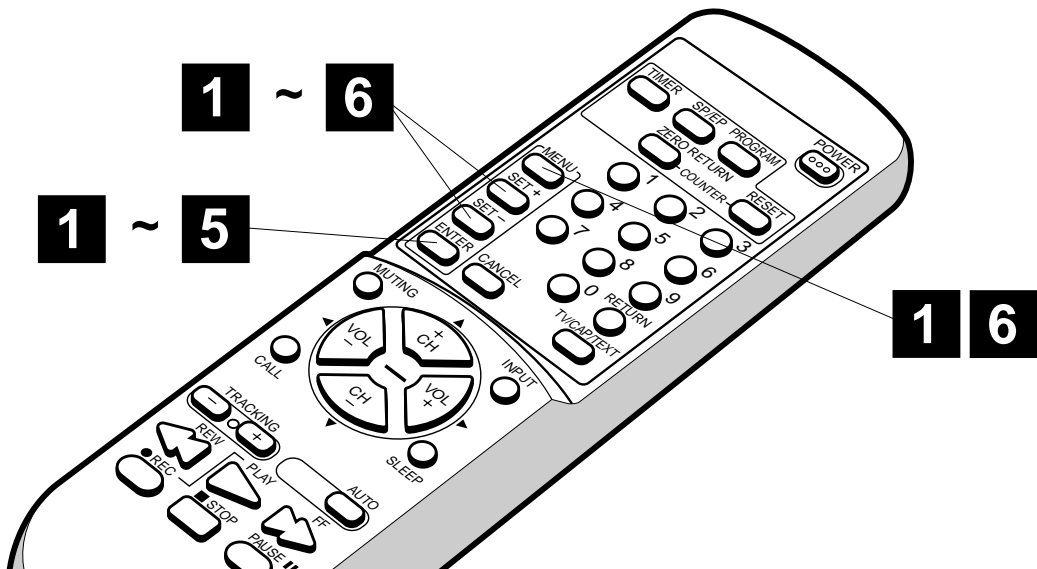

4 Press the SET + or – button to set the desired hour, then press the ENTER button.



ON/OFF TIMER
 ■ ON TIMER 7:00AM CH 012 CANCEL
 SUN-SAT
 ■ OFF TIMER 12:00AM CANCEL

(+/-)/ENTER/CANCEL/MENU

5 Set the desired minute, channel and day of the week as in step 4, then press the ENTER button.



ON/OFF TIMER
 ■ ON TIMER 7:00AM CH 012 CANCEL
 - MON-FRI -
 ■ OFF TIMER 12:00AM CANCEL

(+/-)/ENTER/CANCEL/MENU

6 Press the SET + or – button to select the SET mode, then press the MENU button until the MENU screen is cleared.



ON/OFF TIMER
 ■ ON TIMER 7:00AM CH 012 CANCEL
 MON-FRI -SET-
 ■ OFF TIMER 12:00AM CANCEL



(+/-)/ENTER/CANCEL/MENU

- NOTE:**
- The TV will automatically turn off approximately 1 hour later after the ON TIMER turns on the TV. If you wish to continue watching the TV, press any button to cancel the one hour automatic shut off. This shut off feature prevents the TV from playing continuously if no OFF TIMER is set.
 - To cancel the ON TIMER function; To cancel ON timer, follow above steps 1-6, then press the ENTER button to select the CANCEL position. Press the MENU button to return to the TV.
 - After setting the ON TIMER, "■" of the OFF TIMER will flash on and off. If you wish to set the OFF TIMER, press the ENTER button then follow the steps 4-6 on page 31.
 - If you want to correct the digits while setting, press the CANCEL button until the item you want to correct, then press the SET + or – button to correct the desired setting.

TO SET THE OFF TIMER

This feature allows you to have the TV turn "OFF" automatically at a predetermined time. If you program the OFF TIMER once, the TV will be automatically turned off at the same time daily.

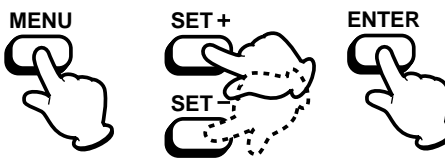
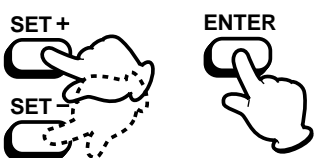
EXAMPLE: Turning off the TV at 11:30 PM.

<p>1 Press the MENU button. Press the SET + or – button to select the TV SET-UP option, then press the ENTER button.</p>  <div data-bbox="319 593 558 772"> <p>MENU ■ TIMER REC SET - TV SET-UP ▲ CH SET-UP ■ AUTO REPEAT ON ▶OFF ■ SYSTEM SET-UP</p> <p><+/-/ENTER/MENU></p> </div>	<p>2 Press the SET + or – button to select the ON/OFF TIMER option, then press the ENTER button.</p>  <div data-bbox="782 593 1021 772"> <p>TV SET-UP ■ V-CHIP SET - ON/OFF TIMER ▲ PICTURE</p> <p><+/-/ENTER/MENU></p> </div>	<p>3 Press the SET + or – button to select the OFF TIMER option, then press the ENTER button.</p>  <div data-bbox="1228 593 1468 772"> <p>ON/OFF TIMER ■ ON TIMER 7:00AM CH 012 SET MON-FRI ■ OFF TIMER 12:00AM CANCEL</p> <p><+/-/ENTER/CANCEL/MENU></p> </div>
--	---	---

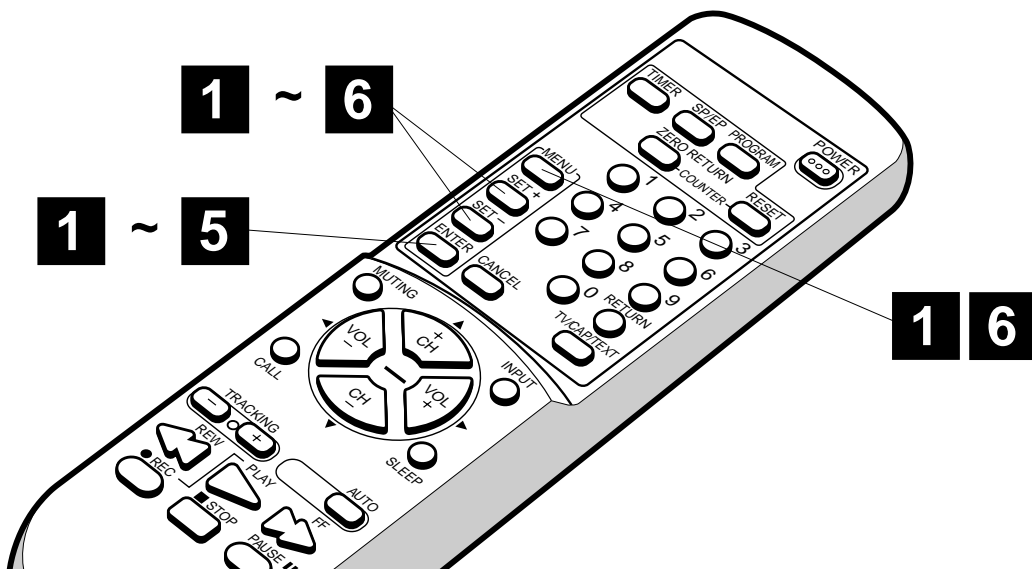

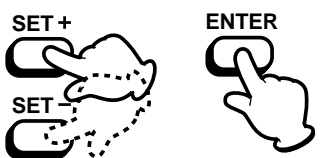
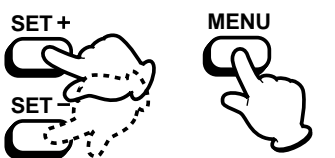
<p>4 Press the SET + or – button to set the desired hour, then press the ENTER button.</p>  <div data-bbox="287 1680 526 1859"> <p>ON/OFF TIMER ■ ON TIMER 7:00AM CH 012 SET MON-FRI ■ OFF TIMER 11:00PM CANCEL</p> <p><+/-/ENTER/CANCEL/MENU></p> </div>	<p>5 Press the SET + or – button to set the desired minute, then press the ENTER button.</p>  <div data-bbox="766 1680 1005 1859"> <p>ON/OFF TIMER ■ ON TIMER 7:00AM CH 012 SET MON-FRI ■ OFF TIMER 11:30PM CANCEL</p> <p><+/-/ENTER/CANCEL/MENU></p> </div>	<p>6 Press the SET + or – button to select the SET mode, then press the MENU button until the MENU screen is cleared.</p>  <div data-bbox="1244 1680 1484 1859"> <p>ON/OFF TIMER ■ ON TIMER 7:00AM CH 012 SET MON-FRI ■ OFF TIMER 11:30PM -SET-</p> <p><+/-/ENTER/CANCEL/MENU></p> </div>
--	---	--

- NOTE:**
- If a station being viewed stops broadcasting, the TV will automatically shut itself off after 15 minutes.
 - **To cancel the OFF TIMER function:**
To cancel OFF timer, follow above step 1-5, then press the SET + or – button to select the CANCEL position. Press the MENU button to return to the TV.
 - **To confirm the ON/OFF TIMER:**
Press the PROGRAM button twice to indicate the programmes on the screen.

LOADING AND UNLOADING A VIDEO CASSETTE

Use only video cassette tapes marked **VHS** and **SVHS**.

LOADING

Push the center of the tape until it is automatically retracted into the TV/VCR.

AUTOMATIC POWER ON AND PLAY

When loading a cassette tape without the erase prevention tab intact, the TV/VCR will turn on automatically and playback will start immediately.

Insert the cassette with its labeled side facing you.
An inverted video cassette cannot be inserted.

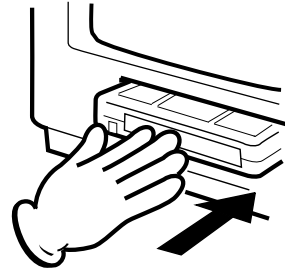
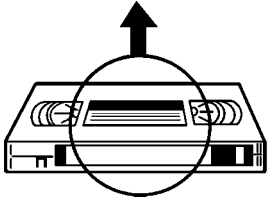

UNLOADING

1

To unload a video cassette, press the STOP/EJECT button on the TV/VCR twice. The first press will stop the tape in any mode. The second press will eject the tape.



AUTOMATIC EJECT

If the TV/VCR automatically rewinds the tape to the beginning (AUTO REWIND FEATURE), the tape will be ejected automatically. (See NOTE on page 38.)

2

Pull the cassette out.

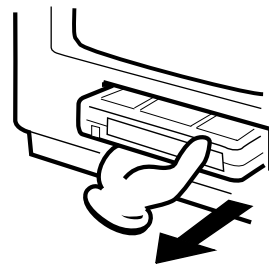

NOTE:

- Always eject the tape when not in use.
- The cassette tape can be ejected even if the POWER is "OFF".

TO PREVENT ACCIDENTAL ERASURE

After recording, break off the erase prevention tab if you do not wish to record over the tape.

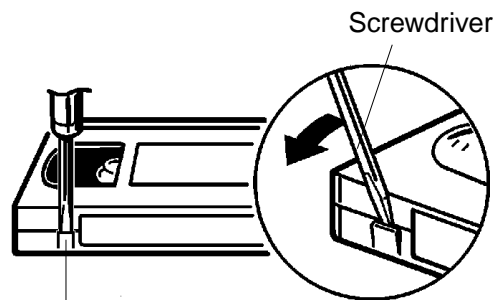

TO RECORD AGAIN

Cover the hole with vinyl tape.

Be careful the tape does not extend past the edges of the video cassette housing.

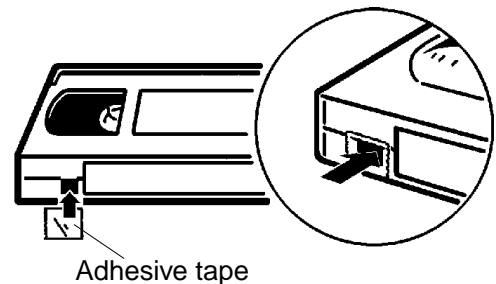

TAPE SPEED AND MAXIMUM RECORDING TIME

TAPE SPEED	VIDEO CASSETTE TAPE				
	T-160	T-120	T-90	T-60	T-30
SP (Standard Play)	2-2/3 hours	2 hours	1-1/2 hours	1 hour	30 minutes
EP (Extended Play)	8 hours	6 hours	4-1/2 hours	3 hours	1-1/2 hours

PLAYBACK

To play a prerecorded tape.

TO START PLAYBACK

1 To turn on the TV/VCR, press the POWER button.



2 Load a prerecorded tape. (When loading a cassette tape without the erase prevention tab, playback will start automatically.)

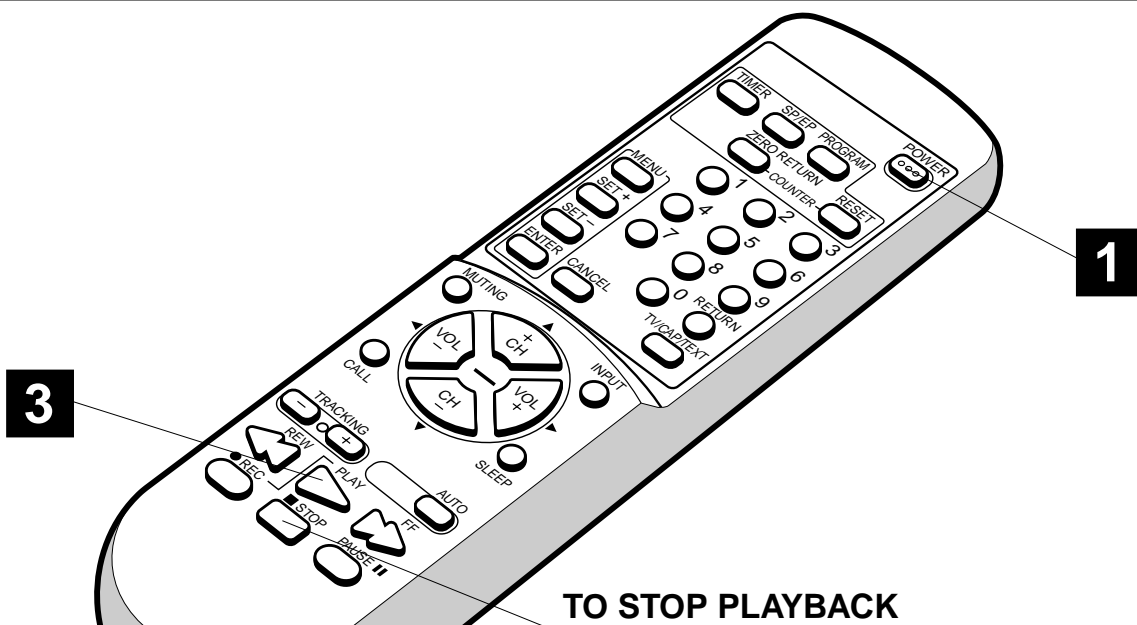
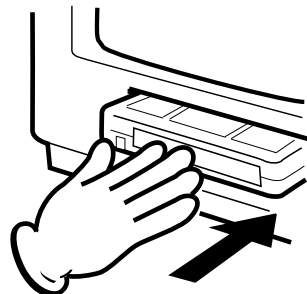

3 Press the PLAY button to begin playback. "▶" will appear on the screen.



TO STOP PLAYBACK

Press the STOP button once. The tape will stop, but remain fully loaded and ready to play.



NOTE: This TV/VCR selects the tape speed SP or EP automatically.

TO REWIND OR FORWARD THE TAPE RAPIDLY

Press the REW (Rewind) button in the Stop mode. "◀◀" will appear on the screen.

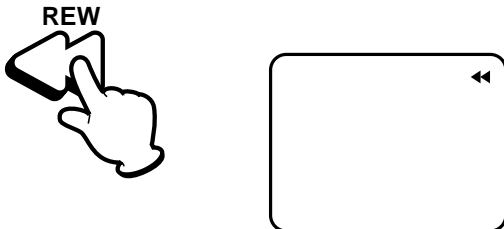

Press the FF (Fast Forward) button in the Stop mode. "▶▶" will appear on the screen.

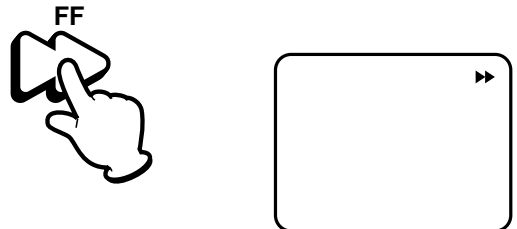

FORWARD/REVERSE PICTURE SEARCH

If you want to see the tape during REW (FF) mode, press and hold the REW (FF) button. The backward (forward) visual search picture will be seen on the screen. Release to return to the REW (FF) mode.

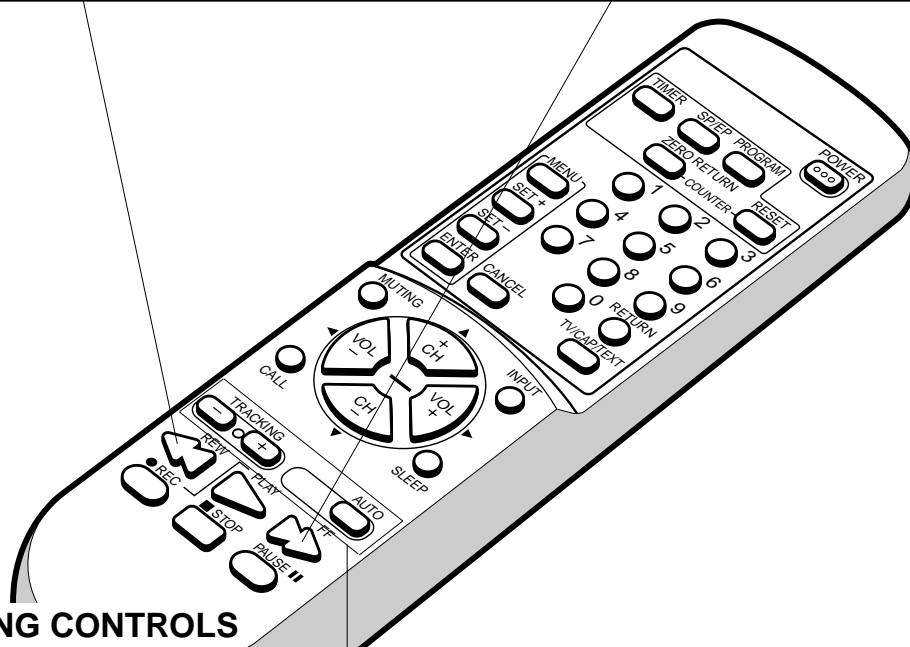

DIGITAL TRACKING CONTROLS

When a tape is played, the Digital Auto Tracking system automatically adjusts the tracking to obtain the best possible picture. If noise bars appear during playback, adjust the tracking manually as follows:

- Press the TRACKING + or - button to obtain the best possible picture. "MANUAL TR." will appear for 4 seconds on the screen.

To resume automatic tracking, press the AUTO TRACKING button. "AUTO TR." will appear for 4 seconds on the screen.

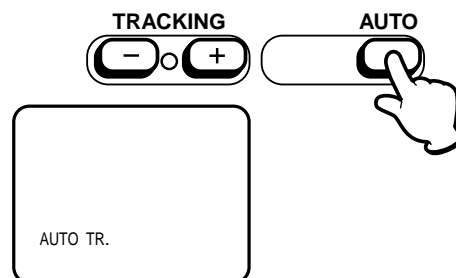
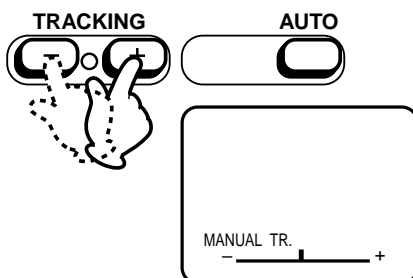

SPECIAL PLAYBACK

TO VISUALLY SEARCH FOR DESIRED POINTS

When either the FF or REW button is pressed in the PLAYBACK mode, the speed search picture will appear. When pressed twice, the search picture will increase speed. Speed search time depends upon the speed used (SP or EP) during recording. See chart below.

To rewind or fast forward a tape, press the STOP button, and then press the REW or FF button.

To visually search backward, press the REW button once or twice in the PLAYBACK mode.



Press the PLAY button to resume normal viewing speed.

To visually search forward, press the FF button once or twice in the PLAYBACK mode.



Press the PLAY button to resume normal viewing speed.

SPEED SEARCH TIMES

TAPE SPEED	PICTURE SEARCH SPEED	
	PRESS ONCE	PRESS TWICE
SP (Standard Play)	3 X	5 X
EP (Extended Play)	9 X	15 X

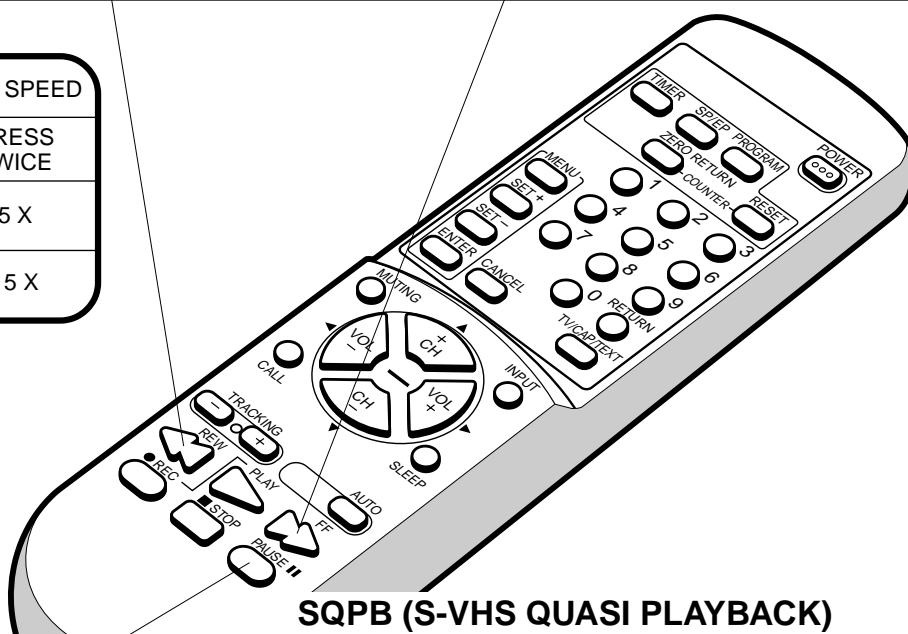

TO WATCH STILL PICTURE

Press the PAUSE button in the PLAYBACK mode.



Press the PLAY button or PAUSE button to resume normal playback.

SQPB (S-VHS QUASI PLAYBACK)

You can play back the video cassette tape recorded in the S-VHS system. However the played back picture does not have the high resolution of S-VHS system.

NOTE: You can not record in S-VHS system.

- NOTE:**
- Best results during speed search and still playback can be obtained with video cassettes recorded in the "EP" mode.
 - The audio output is muted during Speed Search and Still.
 - A few noise bars will appear on the TV screen during Speed Search and Still.
 - To prevent damage to the tape, Still and Speed Search mode is automatically changed to the Playback mode after 5 minutes.

TO WATCH A TAPE REPEATEDLY

1 Press the MENU button.

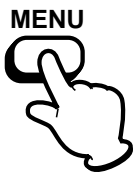

2 Press the SET + or – button to select the AUTO REPEAT option.

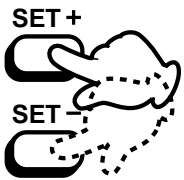

M E N U

- T I M E R R E C S E T
- T V S E T - U P
- ▼ C H S E T - U P
- A U T O R E P E A T O N ▶ O F F
- S Y S T E M S E T - U P

<+/->ENTER/MENU

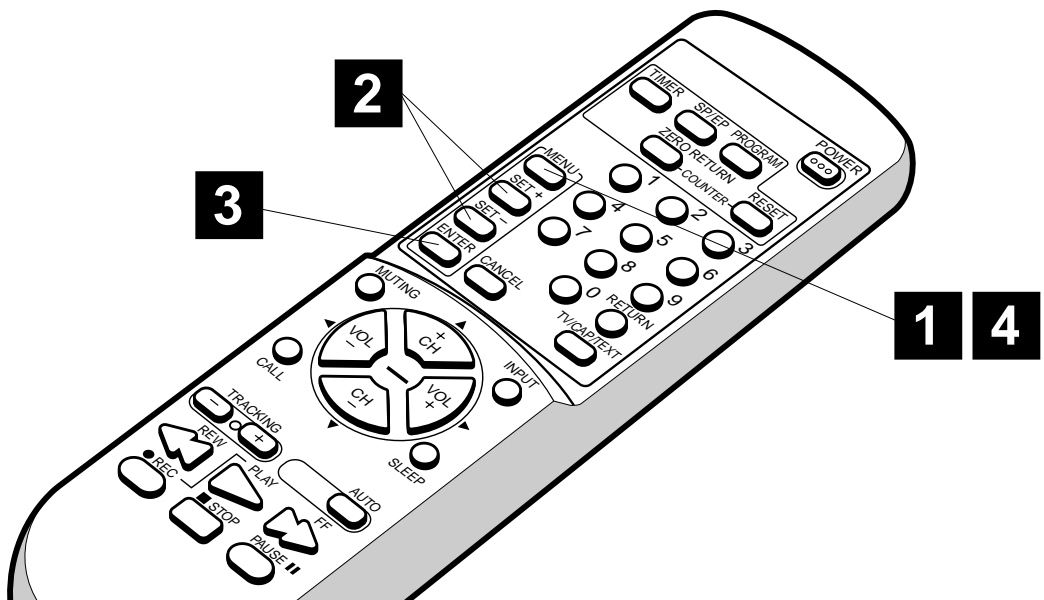

3 Press the ENTER button to select the ON position.

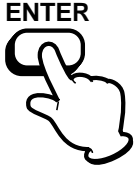

4 Press the MENU button. If you press the PLAY button, the tape will play over and over until the repeat mode is canceled.

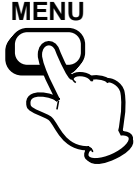

M E N U

- T I M E R R E C S E T
- T V S E T - U P
- ▼ C H S E T - U P
- A U T O R E P E A T ▶ O N O F F
- S Y S T E M S E T - U P

<+/->ENTER/MENU

NOTE:

- To cancel repeat mode, follow above steps 1 and 2, then press the ENTER button to select the OFF position. Press the MENU button to return to the TV.
- The repeat function is canceled automatically when the unit is switched off or the tape is ejected.

RECORDING A TV PROGRAM

RECORDING AND VIEWING THE SAME TV PROGRAM

1 To turn on the TV/VCR, press the POWER button.



2 Load a cassette tape with the erase prevention tab intact.

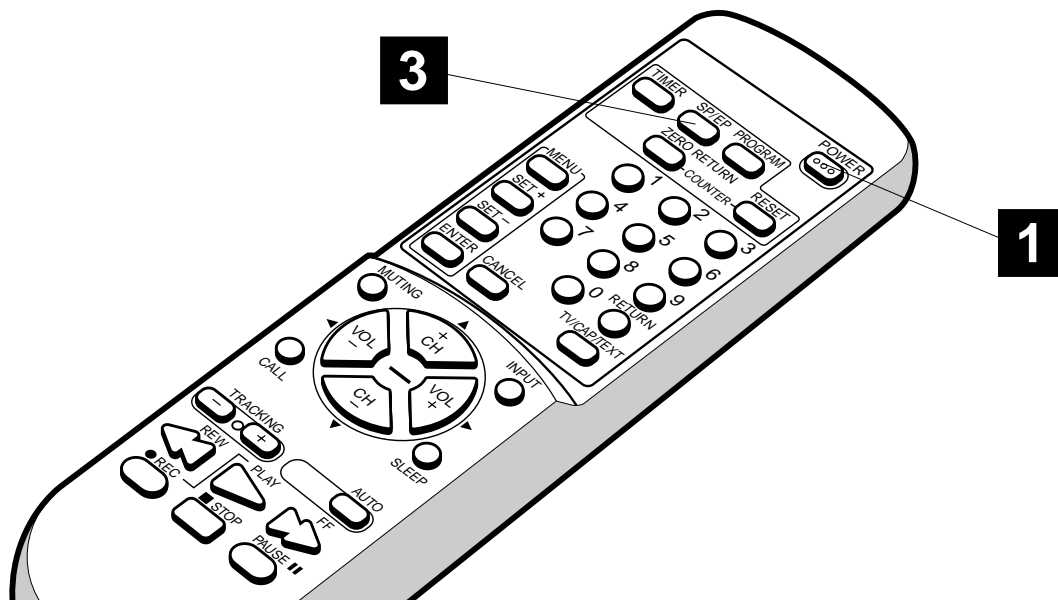
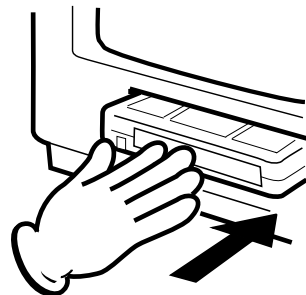

3 Press the SP/EP button to select the desired tape speed (SP or EP). "SP" or "EP" will appear on the screen for 4 seconds.

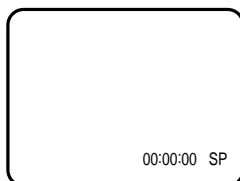

4 Set the TV/CATV option to the appropriate position. (See page 21.)

TV	- VHF/UHF channels
CATV	- CABLE TV channels

NOTE:

- If power is switched off during recording, the TV set goes off and the VCR continues to record. Press the STOP button to halt the recording and turn off the VCR.
- The TV/VCR Channel cannot be changed during recording.

5 Press the Direct Channel Selection buttons to select the channel to be recorded.
(Example: Channel 12)
Or press the CHANNEL + or – button to select the channel to be recorded.

6 Press the REC and the PLAY button simultaneously. The REC indicator will light.

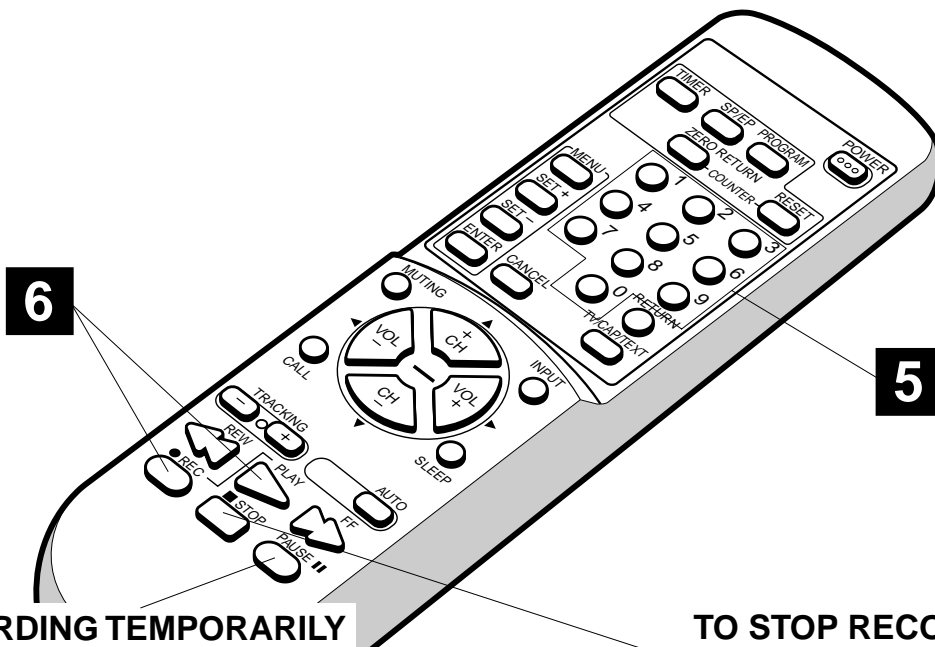

TO STOP RECORDING TEMPORARILY

Press the PAUSE button to avoid recording unwanted material. "II" will appear on the screen and the REC indicator will blink on and off. Press the PAUSE button or the REC button to continue the recording.

NOTE:
The PAUSE mode will be changed to STOP mode after five minutes to prevent damage to the tape.

TO STOP RECORDING

Press the STOP button to stop recording.

NOTE: • **AUTO REWIND FEATURE**

This TV/VCR will automatically rewind the video cassette when the tape has ended (except during ITR and Timer Record). It will also eject the video cassette.

• If the erase prevention tab is removed, the tape will eject when both the REC button and PLAY button are pressed for recording.

INSTANT TIMER RECORDING (ITR)

The Instant Timer Recording feature provides a simple and convenient way to make a timed recording.

EXAMPLE: Instant timer recording for 30 minutes.

1 Press the POWER button to turn on the TV/VCR.



2 Load a video cassette with the erase prevention tab intact.



3 Press the SP/EP button to select the desired tape speed (SP or EP). SP or EP will appear on the screen for 4 seconds. (See page 28 for more information on tape usage.)



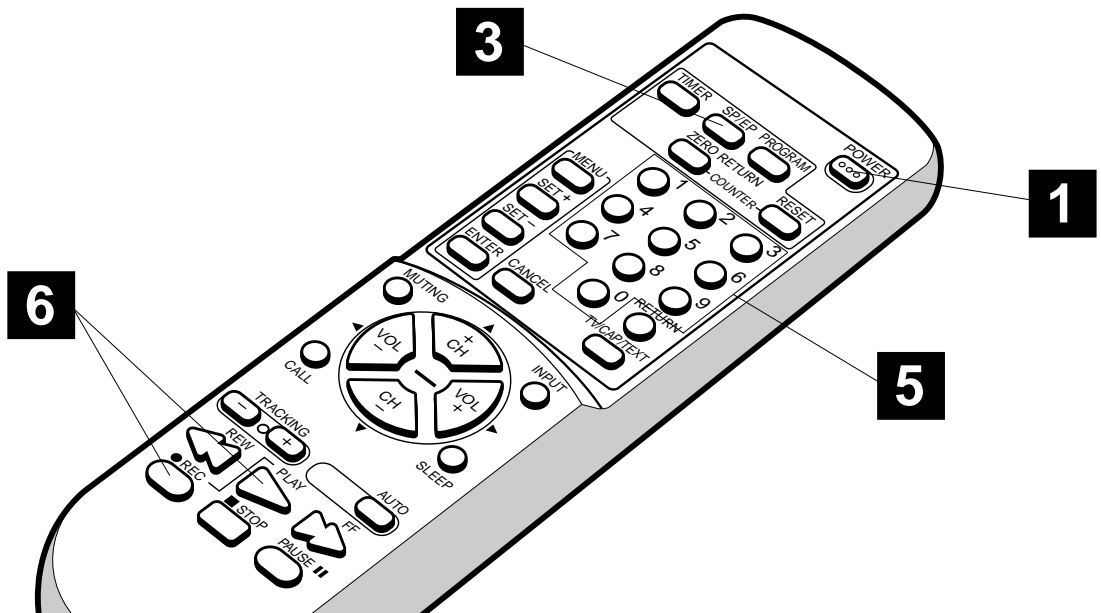

4 Set the TV/CATV option to the appropriate setting.

TV - VHF/UHF channels
CATV - CABLE TV channels

5 Press the Direct Channel Selection buttons to select the channel to be recorded. (Example: Channel 12) Or press and release the CHANNEL + or - button. (See page 17.)

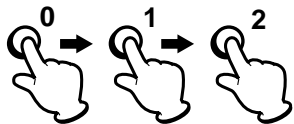

CH 012

6 Press the REC and PLAY buttons simultaneously to begin recording. Press the both buttons again to stop recording after 30 minutes. Each additional press of the both buttons will increase recording time as shown below, up to a maximum of 5 hours. "ITR" will appear on the screen.

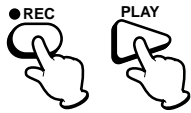

ITR 0:30
CH 012

NOTE: • Press both the REC button and the PLAY button to increase the time needed for recording. (See the chart below.)

Press	once	twice	3 times	4 times	5 times	6 times	7 times	8 times	9 times
Recording time	NORMAL REC	0:30	1:00	1:30	2:00	3:00	4:00	5:00	NORMAL REC

- To cancel Instant Timer Recording, press the STOP button.
- The TV/VCR channel cannot be changed during recording.

TIMER RECORDING

Timer recording can be programmed on-screen with the remote control. The built-in timer allows automatic unattended recording of up to 8 programs within 1 month.

EXAMPLE: Program a timer recording for 23rd. day, channel 007 (CATV), 7:00 - 9:30 PM (Tape speed : EP)

- Load a video cassette with the erase prevention tab intact. The TV/VCR will automatically turn on.
- Set the TV/CATV selection to the appropriate position. (see page 21.)
- See page 9 and 10, REMOTE CONTROL Operation.

1 Press the MENU button.

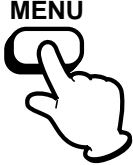

2 Check the TIMER REC SET option is selected, then press the ENTER button.



▶	MENU
▶	TIMER REC SET
▶	TV SET-UP
▶	CH SET-UP
▶	AUTO REPEAT ON/OFF
▶	SYSTEM SET-UP

(<+/->/ENTER/MENU)

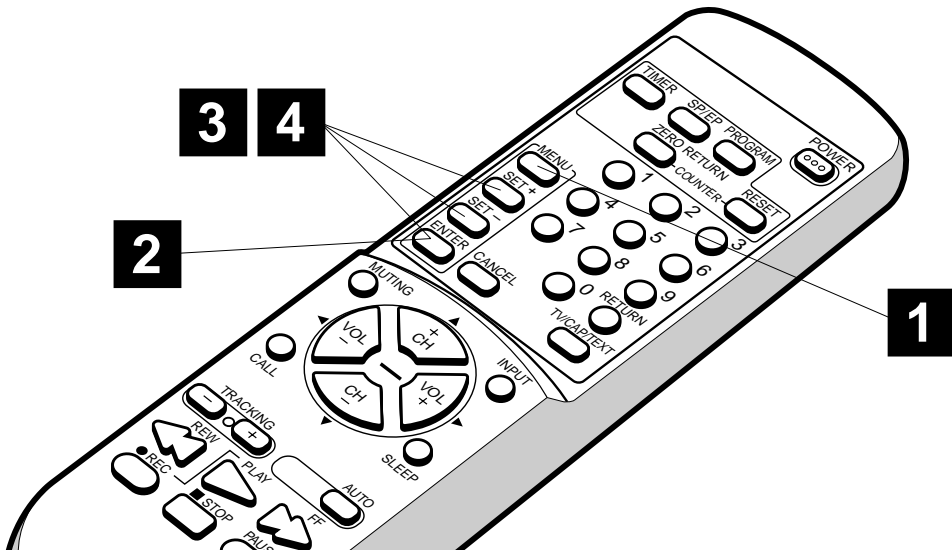

3 Press the SET + or – button to select the PROGRAM position, then press the ENTER button.

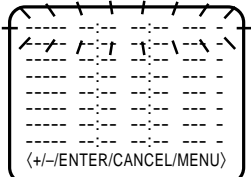
(<+/->/ENTER/CANCEL/MENU)

4 Press the SET + or – button to select the date, then press the ENTER button. See page 42 for the Daily/Weekly Timer.



TIMER REC SET	
DATE	23 (TUE)
START	8:30 AM
END	--:--
CH	012
SPEED	SP

(<+/->/ENTER/CANCEL/MENU)

NOTE: • If programming is performed without a tape in the TV/VCR, or with a tape without an erase prevention tab, the Timer Recording is not possible. If a tape without an erase prevention tab is in the TV/VCR, the tape will be ejected.

• To record from the external equipment press the SET + or – button repeatedly until "L" (LINE) appears when setting the channel in step 5.

5 Set the start time, end time, channel and tape speed as in step 4.

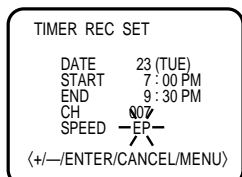

6 Press the ENTER button to accept them.

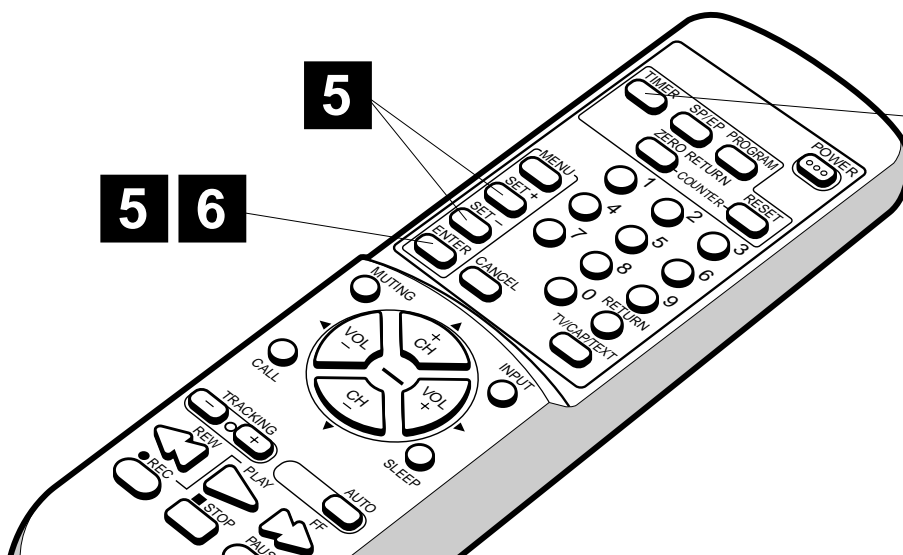
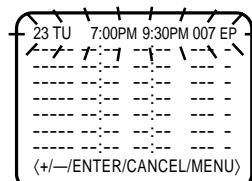

7 To set the timer for another program, press the SET + or – button until the position of the second program blinks, then press the ENTER button. Repeat steps 4 to 6 to set the second program.

8 Press the TIMER button. The REC TIMER indicator will light. The Timer is programmed, when the programmed time is reached, the recording is automatically started.



To cancel timer recording, press the button again and REC TIMER indicator will go out.

- NOTE:**
- The VCR section cannot be used while the REC TIMER indicator is lit. If you want to use the VCR operation, press the TIMER button to deactivate the timer.
 - After a power failure or disconnection of the power plug, all programmed recording setting and time display will be lost upon resumption of power. In this case, reset the clock (see pages 14-16.) and reprogram any timer recordings.
 - If you want to correct the digits while setting, press the CANCEL button until the item you want to correct, then press the SET + or – button to correct the desired setting.

OTHER FUNCTIONS FOR THE TIMER RECORDING

TO SET DAILY/WEEKLY TIMER

When setting the date in the step 4 on page 40, press the SET – button repeatedly when the current day is displayed.

The setting changes as follows:

Example	The current day (Friday)	→	SUN-SAT (Sunday to Saturday)
	↑		↓
	One month later minus one day		MON-SAT (Monday to Saturday)
	↑		↓
	WKL-WED (Weekly Wednesday)		MON-FRI (Monday to Friday)
	↑		↓
	WKL-TUE (Weekly Tuesday)		WKL-THU (Weekly Thursday)
	↑		↓
	WKL-MON (Weekly Monday)		WKL-FRI (Weekly Friday)
	↑		↓
	WKL-SUN (Weekly Sunday)	←	WKL-SAT (Weekly Saturday)

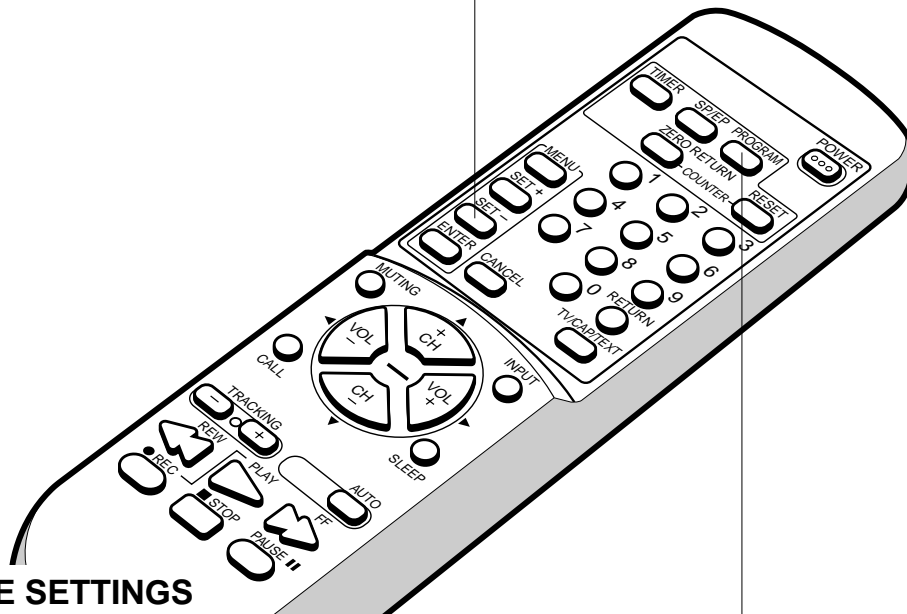

TO CONFIRM THE SETTINGS

Press the PROGRAM (PROGRAM CONFIRM) button once. The TV screen displays the timer program list. Press the PROGRAM button again. The TV screen displays the ON/OFF timer setting.

PROGRAM



(once)

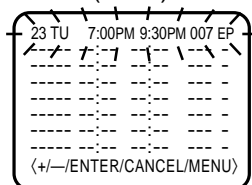

(twice)

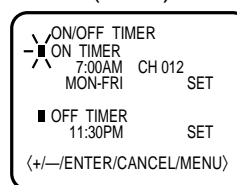

(3 times)



Press the PROGRAM button 3 times. The screen returns to the normal screen.

- NOTE:**
- The everyday/every week recording can be made continuously until the recording is canceled or the tape reaches the end.
 - During timer recording, the automatic rewinding mechanism does not function.
 - You can correct or cancel the programmed setting in program confirm mode.

TO CANCEL A PROGRAM

Press the SET + or – button to select the TIMER REC SET option in the MENU, then press the ENTER button. Press the SET + or – button to select the unnecessary program, and press the CANCEL button to cancel the program.

CANCEL

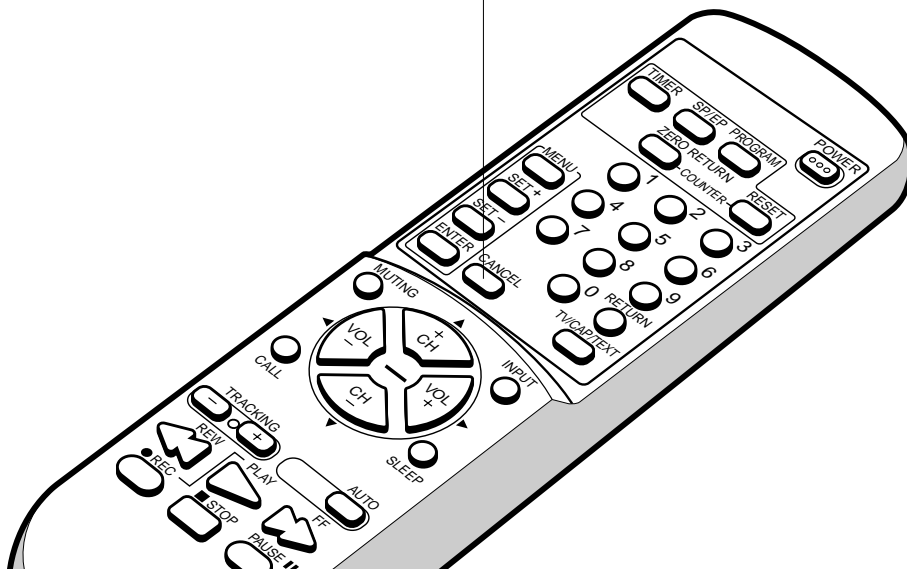
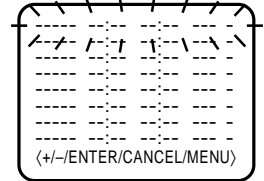

IF THE PROGRAM OVERLAPS ANOTHER

NOTE: Do not overlap programs as portions of the conflicting programs will be lost. The first recording time has priority over the next recording time as shown in the diagram.

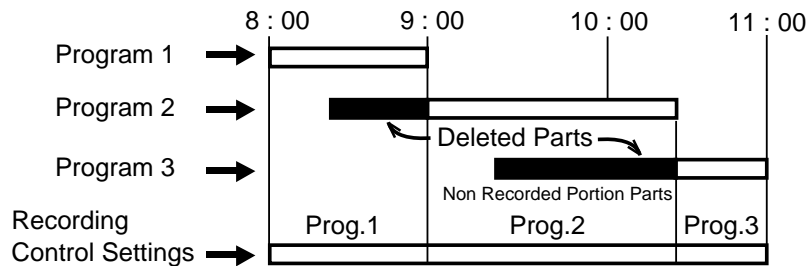



USING THE REAL TIME TAPE COUNTER

The On-Screen Real Time Tape Counter shows the tape running time in Hours, Minutes and Seconds. You can easily determine how long the tape has been running or how much time is left on the tape.

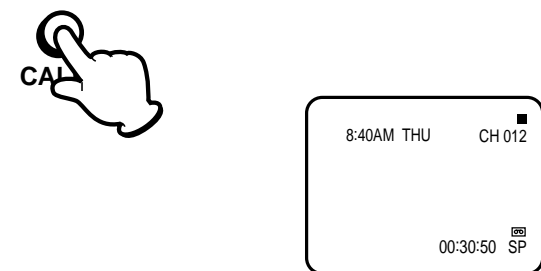
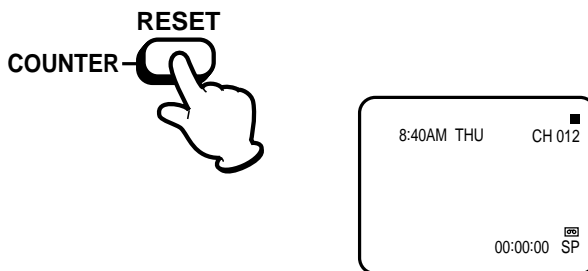
TO VIEW THE COUNTER DISPLAY

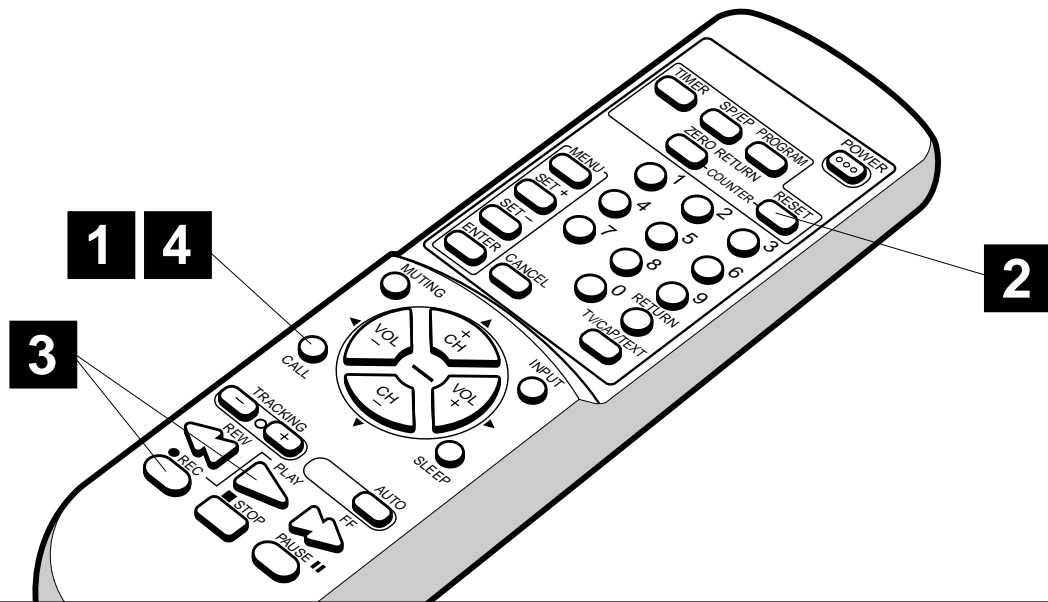
<p>1 Press the CALL button to display the Real Time Tape Counter.</p> 	<p>2 Press the COUNTER RESET button to set the counter to "00:00:00".</p> 
--	---



<p>3 Begin Playback or Recording to start the tape, the counter will display the elapsed time.</p> 	<p>4 When you wish to make the counter disappear, press the CALL button once again.</p> 
---	--

- NOTE:**
- If you rewind the tape from "00:00:00", a minus sign ("-") will be displayed in front of the time.
 - When you load a tape, the counter will reset to "00:00:00".
 - The counter does not function on nonrecorded (blank) sections of the tape. When you rewind, fast forward or play tapes through blank sections, the counter stops.

USING ZERO RETURN

The zero return function provides a convenient method of rapidly returning to the starting point of recording or playback. The starting point can be indexed for any location on the tape by pressing the COUNTER RESET button and COUNTER ZERO RETURN button.

1 Press the CALL button to display the counter.

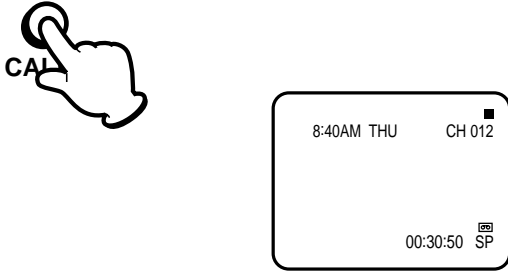

2 Before playback or recording, press the COUNTER RESET button to set the counter to "00:00:00".

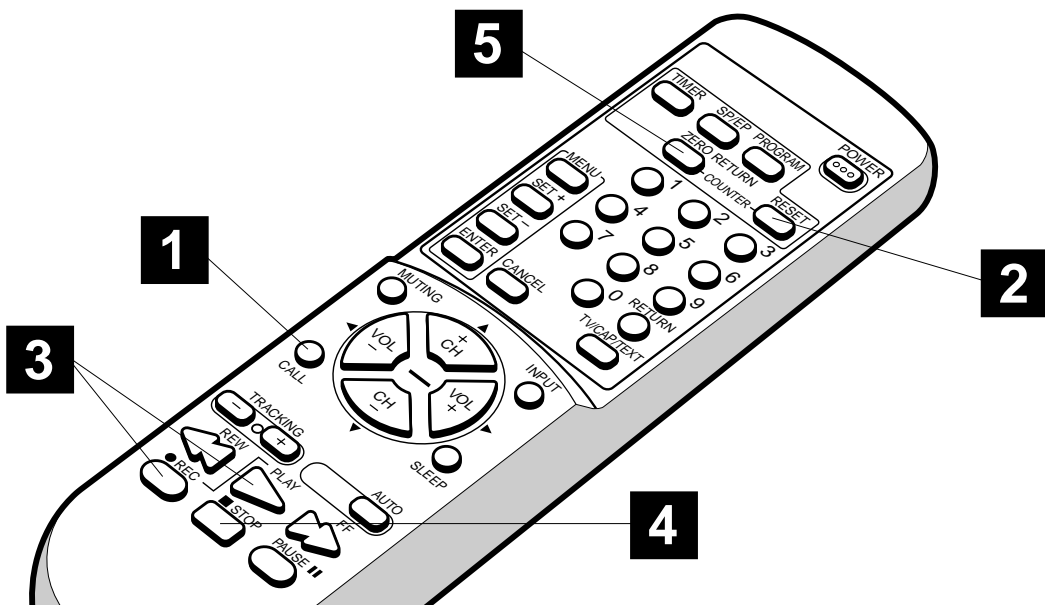
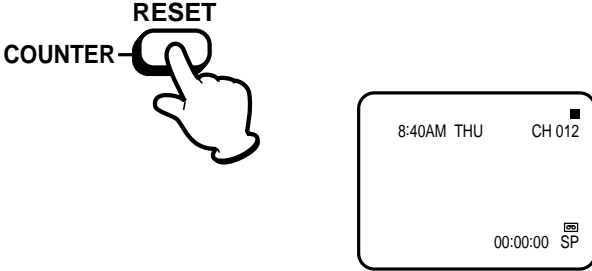

3 Begin playback or recording.

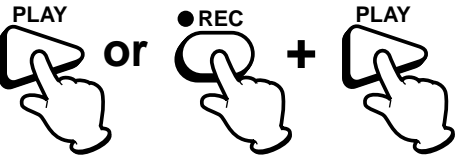

4 Press the STOP button.



5 Press the ZERO RETURN button. The tape will rewind and automatically stop at the "00:00:00" position.

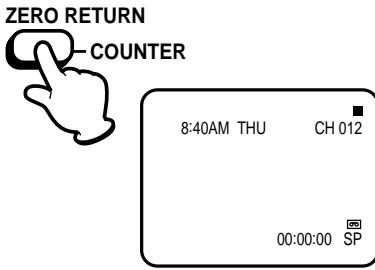

DUPLICATING A VIDEO TAPE

If you connect the TV/VCR to another VCR or CAMCORDER, you can duplicate a previously recorded tape. Make all connections before turning on the power.

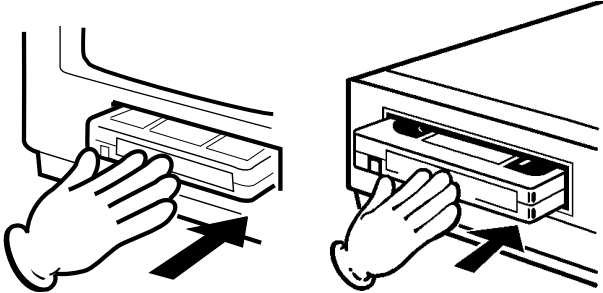
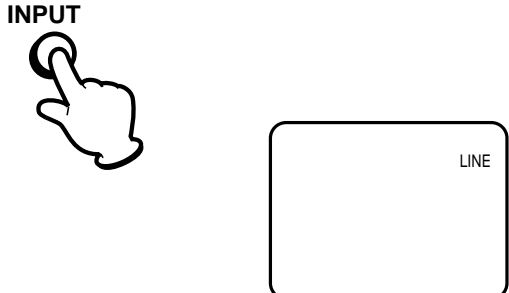
<p>1 Insert a blank cassette with the erase prevention tab intact into the TV/VCR. Insert a previously recorded cassette into the playback VCR or Camcorder.</p> 	<p>2 Press the INPUT button twice select AUDIO/VIDEO input position, The "LINE" will appear on the screen.</p> 
---	--

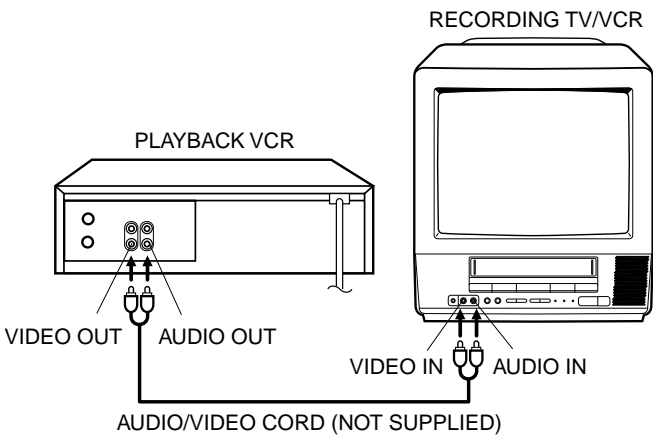

CONNECTION TO ANOTHER VCR

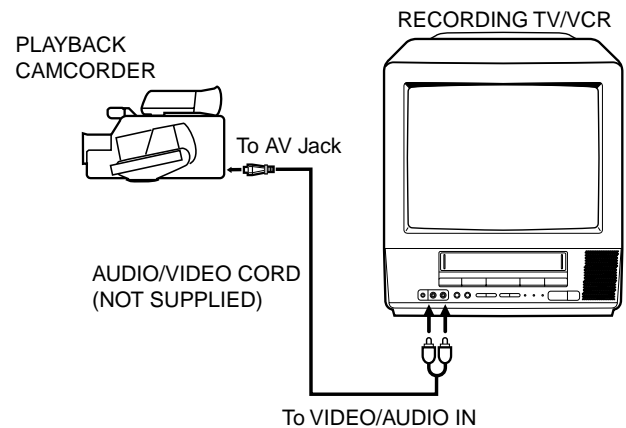

CONNECTION TO CAMCORDER

For duplicating a previously recorded tape from a camcorder, follow the camcorder manufacturer's instructions. A typical camcorder dubbing hookup is shown below.

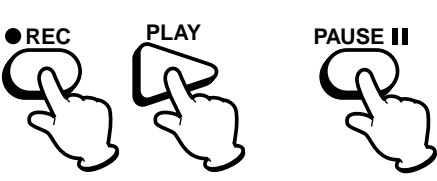

<p>3 Press the REC button and the PLAY button simultaneously on the remote control or the REC button on the TV/VCR, then press the PAUSE button.</p> 	<p>4 Press the PLAY button on the playback VCR.</p> 	<p>5 Press the PAUSE button on the TV/VCR to begin the duplicating process.</p> 
---	--	--

NOTE:

- It is recommended that the tape speed be set to the SP mode on the TV/VCR for best results.
- Unauthorized recording of copyrighted television programs, films, video cassettes and other materials may infringe the rights of copyright owners and be contrary to copyright laws.

RECEPTION DISTURBANCES

Most types of television interference can be remedied by adjusting the height and position of the VHF/UHF antenna. Outdoor antennas are recommended for best results. The most common types of television interference are shown below. If one of these symptoms appear when the TV/VCR is connected to a Cable TV system, the disturbance may be caused by the local Cable TV company broadcast.

IGNITION

Black spots or horizontal streaks may appear, the picture may flutter or drift. Usually caused by interference from automobile ignition systems, neon lamps or AC powered tools and appliances such as drills or hair dryers.



GHOSTS

Ghosts are caused by the television signal following two paths. One is the direct path and the other is reflected by tall buildings, hills or other large objects. Changing the direction or position of the antenna may improve the reception.



SNOW

If the TV/VCR is located far from the TV station, in a fringe reception area where the signal is weak, small dots may appear in the picture. If the signal is extremely weak, the installation of a larger external antenna may be necessary.



RADIO FREQUENCY INTERFERENCE (RFI)

Caused by two-way radios, this type of interference produces moving ripples or diagonal streaks in the picture. Some cases may cause a loss of contrast in the picture. Changing the direction and position of the antenna or installing an RFI filter may improve the picture.



PICTURE SIZE VARIATION

A slight picture size variation is normal when you adjust the CONTRAST or BRIGHTNESS settings.



CARE AND MAINTENANCE

To prevent fire or shock hazard, disconnect the TV/VCR from the AC power source before cleaning. The finish on the cabinet may be cleaned with mild soap and a soft, damp cloth and cared for as other furniture. Use caution when cleaning or wiping the plastic parts.

TROUBLESHOOTING GUIDE

Check the following chart before requesting service.

SYMPTOMS	CAUSE	POSSIBLE SOLUTIONS	PAGE
POWER			
No power.	The AC power cord is not connected.	Connect the AC power cord to the AC outlet.	7
Although the power is on, the TV/VCR does not operate.	Cassette is not inserted.	Insert a video cassette.	32
	TIMER button is depressed.	Press the TIMER button.	41
TV BROADCAST RECEPTION			
Poor or no picture.	TV station experiencing problems.	Try another channel.	17
	Picture control is not adjusted.	Check picture control adjustments.	28, 29
	Possible local interference.	Check for source of reception disturbance.	47
	Antenna (CATV) connector is not connected or possible local interference.	Check CATV connection or VHF/UHF antenna, reposition or rotate antenna.	11, 12
Poor or no color.	TV station experiencing problems.	Try another channel.	17
	Picture control is not adjusted.	Check picture control adjustments.	28, 29
	Possible local interference.	Check for source of reception disturbance.	47
	Antenna (CATV) connector is not connected or possible local interference.	Check CATV connection or VHF/UHF antenna, reposition or rotate antenna.	11, 12
Picture wobbles or drifts.	TV station experiencing problems.	Try another channel.	17
	Antenna (CATV) connector is not connected or possible local interference.	Check CATV connection or VHF/UHF antenna, reposition or rotate antenna.	11, 12
	Cable TV channel is scrambled.	Try another channel.	17
No CATV reception.	CATV connector is not connected.	Check all CATV connections.	12
	TV/CATV Mode menu option is set to the TV mode.	Set the TV/CATV Menu option to the CATV mode.	21
	Cable TV service interrupted.	Contact your Cable TV company.	12
No reception above channel 13.	TV/CATV Mode menu option is not set to the appropriate mode.	Make sure TV/CATV menu option is in the appropriate mode.	21
	UHF antenna is not connected.	Check UHF antenna.	11
Poor or no sound.	TV station experiencing problems.	Try another channel.	17
	Antenna (CATV) connector is not connected or possible local interference.	Check CATV connection or VHF/UHF antenna, reposition or rotate antenna.	11, 12
	Possible local interference.	Check for source of reception disturbance.	47
	MUTING button is depressed.	Check that MUTING button has not been pressed.	18

SYMPTOMS	CAUSE	POSSIBLE SOLUTIONS	PAGE
TV shuts off.	TV station stopped broadcasting.	Tune new channel.	17
	Sleep timer is set.	Set Sleep Timer to "0".	19
Closed caption is not activated.	TV station experiencing problems or program tuned is not closed captions.	Try another channel.	17, 19
	TV signal is weak.	Check CATV connection of VHF/UHF antenna, reposition or rotate antenna.	11, 12
	The TV/CAP/TEXT button is not depressed.	Press the TV/CAP/TEXT button to turn on the closed caption.	19, 20
RECORDING			
TV recording does not work.	The video cassette's erase prevention tab is broken off.	Place a piece of vinyl tape over the hole.	32
Timer recording does not work.	The time is not set correctly.	Reset the present time.	14-16
	The recording start/end time is not set correctly.	Reset the start/end time.	40, 41
	The TIMER button has not been pressed (the REC TIMER indicator is not lit.).	Press the TIMER button (the REC TIMER indicator is lit.).	41
PLAYBACK			
Noise bars appear on the screen.	Tape is old or worn.	Replace the tape.	—
	Tracking adjustment is beyond range of automatic tracking circuit.	Adjust tracking manually using the TRACKING + and – buttons on the remote control.	34
	Video heads are dirty.	Clean the video heads.	50
REMOTE CONTROL			
Remote control does not operate.	The remote control is not aimed at the sensor.	Aim the remote control at the remote sensor.	10
	Distance is too far or too much light in the room.	Operate within 15 feet or reduce the light of the room.	10
	There is an obstacle in the path of the beam.	Clear the path of the beam.	10
	The batteries are weak.	Replace the batteries.	10
	The batteries are not inserted correctly.	Insert correctly.	10
MENU			
Can not select MENU OPTION.	Before setting the clock, you can operate only 3 Menu options, CLOCK SET/LANGUAGE/AUTO CLOCK.	Set the clock.	14, 16

VIDEO HEAD CLEANING

VIDEO HEAD CLOGGING

The video heads are the means by which the TV/VCR reads the picture from the tape during playback. In the unlikely event that the heads become dirty enough to be clogged, no picture will be played back. This can easily be determined if, during playback of a known good tape, there is good sound, but no picture (picture is extremely snowy). If this is the case, have the TV/VCR checked by qualified service personnel.



Good Picture

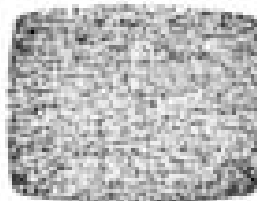

Snowy Picture

VIDEO HEAD CLEANING

AUTO HEAD CLEANING system cleans the video heads automatically when a cassette is inserted or ejected to prevent dirt from accumulating on the heads. However, manual head cleaning is needed if the picture on playback is still unclear although the picture on program is normal. This failure signifies that the head is getting dirty and occurs when playing poor quality or damaged tapes. If the heads require cleaning, use a high quality head cleaning system or have them cleaned professionally.

- NOTE:**
- DO NOT ATTEMPT TO CLEAN THE VIDEO HEADS OR SERVICE THE UNIT BY REMOVING THE REAR COVER.
 - Video heads may eventually wear out and should be replaced when they fail to produce clear pictures.
 - To help prevent video head clogging, use only good quality VHS tapes. Discard worn out tapes.

NOTES

Auto Clock Setting

Notes for Canadian customers regarding the clock feature of the TV-13142 and TV-13142W:

The XDS signals are carried only by certain broadcast television stations (for example, the signal is carried by most Public Broadcasting Service stations). You must be able to receive a station carrying the XDS signal to use the Auto Clock Setting to set your TV/VCR's internal clock. If you live in an area that does not broadcast XDS signals, you must set the clock manually. Please see page 16 for instructions on how to manually set your TV/VCR's clock.

Special note for residents of Newfoundland:

The Auto Clock Setting cannot be used to set the TV/VCR's internal clock to Newfoundland time. The time zone command does not include a setting for the Newfoundland time zone. Trying to use the Auto Clock Setting in the Newfoundland time zone could result in an incorrect time setting or no setting at all. Please set your TV/VCR's clock using the Manual Clock Setting.

SPECIFICATIONS

TELEVISION

Picture Tube:	13" (measured diagonally)
Tuner Type:	Quartz PLL Frequency Synthesized
Receiving Channels:	VHF 2-13 UHF 14-69 CATV 14-36 (A)-(W) 37-59 (AA)-(WW) 60-85 (AAA)-(ZZZ) 86-94 (86)-(94) 95-99 (A-5)-(A-1) 100-125 (100)-(125) 01 (5A)
Antenna Input:	VHF/UHF In 75 ohms coaxial
Speaker:	1.5" x 2.5", 8 ohms x 1
Audio Output Power:	1.5W

VCR

Video System:	VHS, 4 Rotary Heads Helical Scanning System
Video Signal:	NTSC Color
Cassette Tape:	VHS
Audio Track:	1 Track
Tape Speed:	SP/EP
F.FWD/REW Time:	F.FWD: Approx. 4 minutes and 50 seconds REW: Approx. 2 minute and 30 seconds (T-120 Cassette)

GENERAL

Power Source:	AC 120V 60Hz
Power Consumption:	65 Watts
Dimensions:	W 14 1/4" x D 14 1/2" x H 15 1/16"
Weight:	24.3 lbs/11kg
Inputs:	Video: In (RCA) 1Vp-p 75 ohm Audio: In (RCA) 300 mV/50K ohm
Phone Jack:	3.5mm mini-jack

Accessories:

Remote Control
Batteries (AA) X 2

Specifications are subject to change without notice.

JVC®

JVC COMPANY OF AMERICA

Division of U.S. JVC CORP.
1700 Valley Road
Wayne, New Jersey 07470

JVC CANADA, INC.

21 Finchdene Square
Scarborough, Ontario
Canada M1X 1A7

